



Drainage Report

Slate Upper School

5100 Ridge Road

North Haven, Connecticut

October 27, 2020

(Revised December 10, 2020)

(Revised February 17, 2021)

Prepared for:

The Slate School, Inc.
124 Mansfield Road
North Haven, Connecticut 06473

MMI #6156-03-07

Prepared by:

MILONE & MACBROOM, INC.
99 Realty Drive
Cheshire, Connecticut 06410
(203) 271-1773
mminc.com | slrconsulting.com



DRAINAGE REPORT

Slate Upper School | 5100 Ridge Road | North Haven, Connecticut

October 27, 2020 **(Revised December 10, 2020) (Revised February 17, 2021)**
MMI #6156-03-07

This Drainage Report has been prepared in support of the proposed Slate Upper School project to be located at 5100 Ridge Road in the town of North Haven, Connecticut. The site is currently occupied by the existing Mount Carmel Christian Church building. The project proposes to renovate the existing building and parking area and construct a new private school that will have one new building, a central plaza area, new surface parking spaces, a new bituminous driveway off Ridge Road, concrete sidewalks, and all the associated site infrastructure necessary to support the proposed use.



Figure 1 – #5100 Parcel

**TABLE 1
Stormwater Data**

Site Total Area	2.97 acres
Existing Development Impervious Area	0.40 acres
Proposed Development Impervious Area	0.99 acres
Soil Types (Hydrologic Soil Group)	"B," "C," and "D"
Existing Land Use	Woods, open space, gravel, building, parking lot, and bituminous road
Proposed Land Use	Woods, open space, green roof, conventional building roof, parking lot, sidewalk, pavers, and bituminous road
Design Storm for Stormwater Management	No increases in peak rates of runoff for the 1-, 2-, 10-, 25-, 50-, and 100-year storms. First-flush runoff retention (CTDEEP WQV) and Water Quality Flow (WQF)
Water Quality Measures	2-foot-sump catch basins, hydrodynamic separator, isolator row in an underground detention system, green roof, riprap energy dissipator, sediment forebay, retention storage, and riprap level spreader
Design Storm for Storm Drainage	25-year storm
Federal Emergency Management Agency Special Flood Hazard Areas	Zone X (Area of Minimal Flood Hazard)
Connecticut Department of Energy & Environmental Protection Aquifer Protection Areas	Mount Carmel – Level A

STORMWATER MANAGEMENT APPROACH

The stormwater management system for this site has been designed utilizing Best Management Practices (BMPs) to provide water quality management while attenuating the proposed peak-flow rates from the new development. The design goal is to provide water quality treatment in accordance with the Connecticut Department of Energy & Environmental Protection (CTDEEP) requirements for Water Quality Volume (WQV) and prevent increases in the predevelopment runoff rates from the project site. Existing drainage patterns will be maintained to the maximum extent practicable and a stormwater treatment train is proposed, including several water quality measures such as catch basins with 2-foot sumps, a hydrodynamic separator, an isolator row integrated within the underground chamber system, a green roof for a portion of the new building, a riprap energy dissipator, a sediment forebay, a riprap level spreader, and retention volume within the proposed aboveground stormwater basin.

The proposed project will include one aboveground stormwater basin and one underground detention system that are designed to mitigate the increase in stormwater runoff due to the new impervious surfaces. The aboveground basin, designated as Stormwater Basin 110 on the proposed plans, will provide retention storage along its bottom to address the CTDEEP WQV. The basin will have an outlet control structure on its

western side made of reinforced concrete and fitted with an open grate. The proposed underground detention system, designated on the site plans as Stormwater Basin 120, consists of two rows of arched plastic chambers that will be fitted with an outlet control structure in the form of a standard manhole structure with an internal weir wall. The stormwater runoff discharge from the two stormwater management areas will be conveyed to a riprap level spreader, which will then overflow toward the existing wetland system to the west.

The computer program entitled *Hydraflow Storm Sewers Extension for AutoCAD® Civil 3D® 2019* by Autodesk, Inc., Version 10.5, was used for designing the proposed storm drainage collection system. Storm drainage computations performed include pipe capacity and hydraulic grade line calculations. The contributing watershed to each individual catch basin inlet was delineated to determine drainage area and land coverage. These values were used to determine the stormwater runoff to each inlet using the Rational Method. The rainfall intensities for the site were obtained from the National Oceanic and Atmospheric Administration (NOAA) Atlas 14, Volume 10, Precipitation Frequency Data Server (PFDS). The proposed storm drainage system is designed to provide adequate capacity to convey the 25-year storm event.

WATER QUALITY MANAGEMENT

Stormwater runoff from the proposed improvements will be collected by a subsurface pipe and catch basin drainage system. The proposed drainage system will include catch basins with 2-foot sumps that will trap sediments. The underground detention system will incorporate an isolator row that consists of a row of chambers where stormwater is further treated prior to entering the storage chamber system, thus enhancing sediment removal and protecting the storage chambers from sediment accumulation.

The new building will be partially covered by a green roof. This low-impact development practice incorporates vegetation and a growing medium planted over a waterproofing membrane. This water quality measure reduces the effective impervious coverage and improves stormwater management by reducing the amount of runoff, filtering dust and airborne particles, and reducing the heat island effect.

A hydrodynamic separator such as a CDS® unit, manufactured by Contech Engineered Solutions, will be installed prior to the stormwater discharge into the aboveground basin. This unit will further remove suspended solids before discharging downgradient, which will in turn remove other pollutants that tend to attach to the suspended solids and effectively remove other debris and floatables that may be present in stormwater runoff. The CDS® unit has been designed to meet criteria recommended by the CTDEEP 2004 *Stormwater Quality Manual*. The device was designed based on the determined WQF, which is the peak-flow rate associated with the WQV, and sized based on the manufacturer's specifications.

A sediment forebay is proposed around the proposed drainage pipe discharge locations into the aboveground basin, which will improve water quality by trapping floatables as well as filtering coarse sediment and other pollutants. The forebay will be constructed using a riprap filter berm and riprap splash pads. The proposed riprap splash pads will dissipate the potential erosive velocity of stormwater entering the basin as well as trap sediments. The sediment forebay will contain the deposited sediment within a small area of the basin and will allow for maintenance accessibility.

The aboveground stormwater basin will provide retention volume along its bottom, thus creating a water quality feature within it. This serves several purposes, including stormwater renovation and first-flush

retention. The vegetation will provide pollutant removal by filtering stormwater runoff and utilizing excess nutrients that may be present in the stormwater. The CTDEEP *2004 Stormwater Quality Manual* (Chapter 7) recommends methods for sizing stormwater treatment measures with WQV computations. The WQV addresses the initial stormwater runoff, also commonly referred to as the "first flush" runoff. The WQV provides adequate volume to store the runoff associated with the first 1 inch of rainfall, which tends to contain the highest concentration of potential pollutants. The storm drainage system has been designed to convey the "first flush" runoff from all the proposed parking areas, central plaza area, and buildings to the aboveground basin where retention storage will be provided for water quality treatment. Supporting calculations have been included in the Appendix of this report.

The riprap level spreader system was designed to safely release the stormwater discharge from both stormwater management areas. The design calls for a level stone berm as an overflow outlet, which will be set against a precast concrete curb. The stone level spreader will gradually release stormwater in a quiescent manner as sheet flow rather than a concentrated point discharge that results from typical storm pipe outlets or flared end sections.

HYDROLOGIC ANALYSIS

A hydrologic analysis was conducted to analyze the predevelopment and post-development peak-flow rates from the site. The ultimate stormwater runoff discharge from the site is toward the wetland system that abuts the northern and western property boundaries, which was chosen as the analysis point for this hydrologic analysis. The upstream areas that drain onto the site were also incorporated as part of the analysis. The total combined watershed area delineated is approximately 4.9 acres under both existing and proposed conditions.

The method of predicting the surface water runoff rates utilized in this analysis was a computer program entitled *Hydraflow Hydrographs Extension for AutoCAD® Civil 3D® 2019* by Autodesk, Inc., Version 2020. The *Hydrographs* program is a computer model that utilizes the methodologies set forth in the *Technical Release No. 55 (TR-55)* manual and *Technical Release No. 20 (TR-20)* computer model, originally developed by the United States Department of Agriculture – Natural Resources Conservation Service (USDA-NRCS). The *Hydrographs* computer modeling program is primarily used for conducting hydrology studies such as this one.

The *Hydrographs* computer program forecasts the rate of surface water runoff based upon several factors. The input data includes information on land use, hydrologic soil type, vegetation, contributing watershed area, time of concentration, rainfall data, storage volumes, and the hydraulic capacity of structures. The computer model predicts the amount of runoff as a function of time, with the ability to include the attenuation effect due to dams, lakes, large wetlands, floodplains, and stormwater management basins. The input data for rainfalls with statistical recurrence frequencies of 1, 2, 10, 25, 50, and 100 years was obtained from the NOAA Atlas 14, Volume 10, database. The corresponding rainfall totals are listed below.

Storm Frequency	Rainfall (inches)
1 year	2.85
2 year	3.50
10 year	5.44
25 year	6.65
50 year	7.54
100 year	8.51

Land use for the site under existing and proposed conditions was determined from field survey, town topographic maps, and aerial photogrammetry. Land use types utilized in the analysis included woods, grassed or open space, gravel, green roof, conventional building roof, and impervious (paved) cover. Soil types in the watershed were determined from the CTDEEP Geographic Information System (GIS) database of the USDA-NRCS soil survey for New Haven County, Connecticut. The different land uses and soil types were utilized to determine composite runoff Curve Numbers (CN) for each subwatershed. The time of concentration (Tc) was estimated for each subwatershed using the TR-55 methodology, which was computed by summing all travel times through the watershed as sheet flow, shallow concentrated flow, and channel flow.

The existing conditions were modeled with the *Hydrographs* program to determine the peak-flow rates for the various storm events at the analysis point. A revised model was developed incorporating the proposed site conditions and the two proposed stormwater management areas. The stormwater flows obtained with the revised model were then compared to the results from the existing conditions model. The aboveground basin has been designed such that it provides a minimum of 1 foot of freeboard from the water surface elevation to the top of the proposed berm during the 100-year storm event. The underground detention system has been designed such that the estimated water surface elevation within the chambers during the 100-year storm event does not exceed the top of the stone layer above the chambers. The following peak rates of runoff were obtained from the *Hydrographs* hydrology results:

Analysis Point A – Wetland System						
	Peak Runoff Rate (cubic feet per second)					
Storm Frequency (years)	1	2	10	25	50	100
Existing Conditions	2.9	4.7	11.3	15.9	19.3	23.1
Proposed Conditions	2.8	4.4	11.2	15.9	19.2	22.7

Aboveground Detention Basin 110*						
	Water Surface Elevation (feet)					
Storm Frequency (years)	1	2	10	25	50	100
Proposed Conditions	157.0	157.2	157.7	157.7	157.8	157.8

*Top Elevation of Basin = 158.8 feet

Underground Detention System 120**						
	Water Surface Elevation (feet)					
Storm Frequency (years)	1	2	10	25	50	100
Proposed Conditions	171.5	171.8	173.4	174.5	175.5	175.9

****Top Elevation of Stone Above Chambers = 177.0**

CONCLUSION

The results of the hydrologic analysis demonstrate that there will be no increases in peak-flow rates from the proposed development. This was achieved for the storm events modeled through a planned stormwater management system with detention provided in both the aboveground and subsurface detention basins. The proposed development will also introduce a new stormwater treatment train consisting of several water quality measures such as catch basins with 2-foot sumps, a hydrodynamic separator, an isolator row integrated within the underground chamber system, green roof system, riprap energy dissipator, sediment forebay, retention volume within the proposed aboveground stormwater basin, and a riprap level spreader.

The hydrodynamic separator device will be employed to pretreat the stormwater runoff generated from the proposed paved driveway and parking area prior to it entering the underground detention system. A CDS® unit, manufactured by Contech Engineered Solutions, was selected and sized based on the contributing WQF, which is the peak-flow rate associated with the WQV. Furthermore, the CTDEEP WQV has been provided within the retention storage area along the bottom of the proposed aboveground stormwater basin. The "first flush" runoff from all the proposed parking areas, central plaza area, and buildings will be conveyed to the aboveground basin where retention storage will be provided for water quality treatment. The stormwater runoff discharge from the stormwater management areas will be directed to a riprap level spreader that will gradually release stormwater runoff to the wetland system to the west.

All supporting documentation and stormwater-related computations are attached to this report along with the *Hydraflow Hydrographs* model results for stormwater management and *Hydraflow Storm Sewers* model results for the proposed storm drainage system. Illustrative watershed maps for both existing and proposed conditions are also attached to this report.

Attachments

- Attachment A – United States Geological Survey Location Map
- Attachment B – Federal Emergency Management Agency Flood Insurance Rate Map
- Attachment C – Natural Resources Conservation Service Hydrologic Soil Group Map
- Attachment D – Storm Drainage Computations
- Attachment E – Water Quality Computations
- Attachment F – Hydrologic Analysis – Input Computations
- Attachment G – Hydrologic Analysis – Computer Model Results
- Attachment H – Watershed Maps

16156.00003.f1721.rpt.docx

ATTACHMENT A

UNITED STATES GEOLOGICAL SURVEY LOCATION MAP

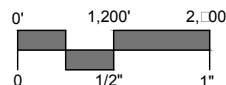
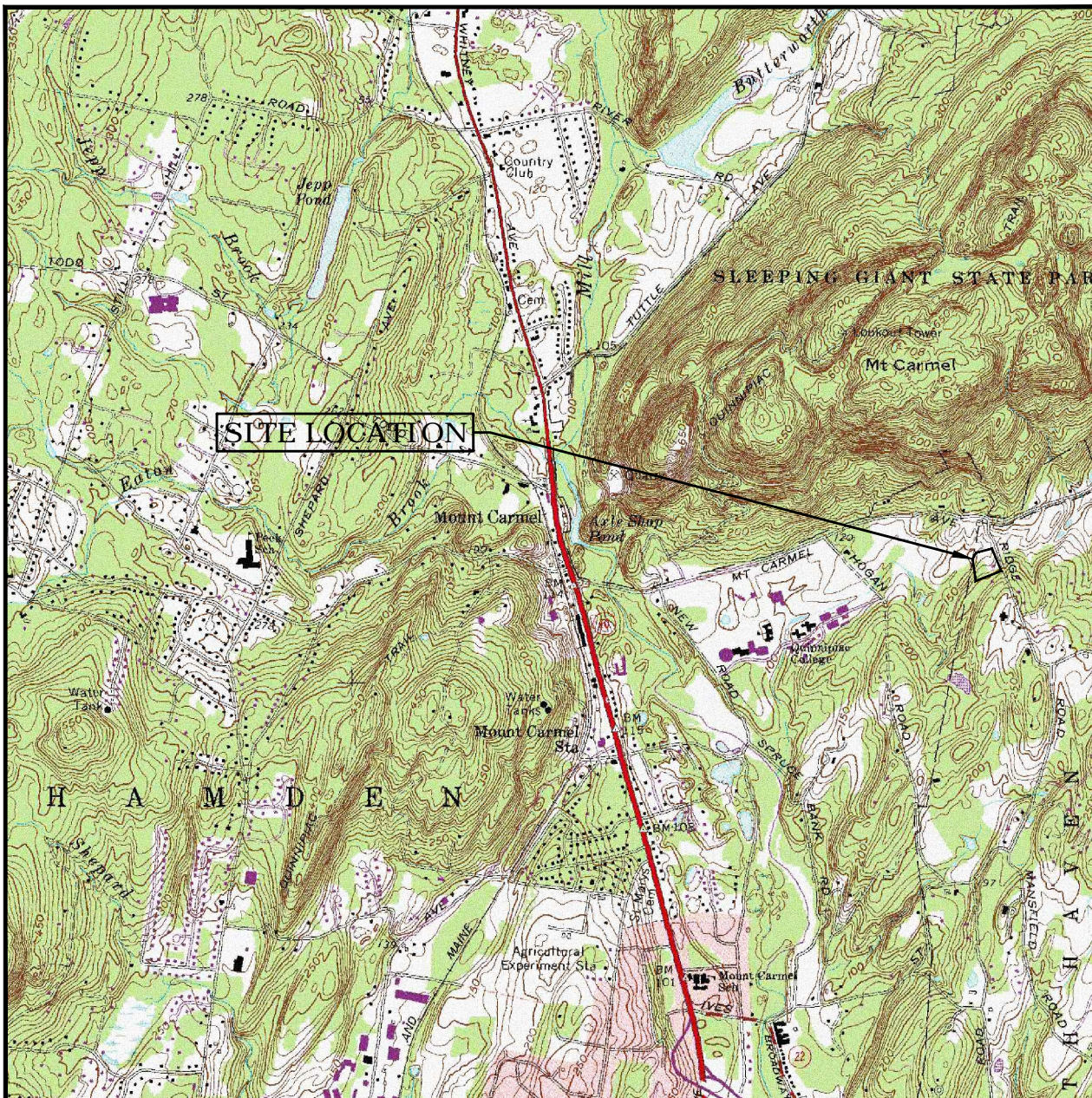

MILONE & MACBROOM
 NOW PART OF **SLR**

99 REALTY DRIVE
 CHESHIRE, CT 06410
 203.271.1773
 WWW.MIMNC.COM | SLRCONSULTING.COM

USGS QUADRANGLE MAP, QUAD NO. 80
SLATE UPPER SCHOOL

5100 RIDGE ROAD
NORTH HAVEN, CONNECTICUT

PROJECT PHASE

RE ---

DATE **OCT. 27, 2020**

SCALE **1"=2400'**

PROJ. NO. **6156-03**

DESIGNED	DRAWN	CHECKED
---	FAB	---

DRAWING NAME

LOC

ATTACHMENT B

FEDERAL EMERGENCY MANAGEMENT AGENCY FLOOD INSURANCE RATE MAP

National Flood Hazard Layer FIRMMette



72°53'16"W 41°25'31"N

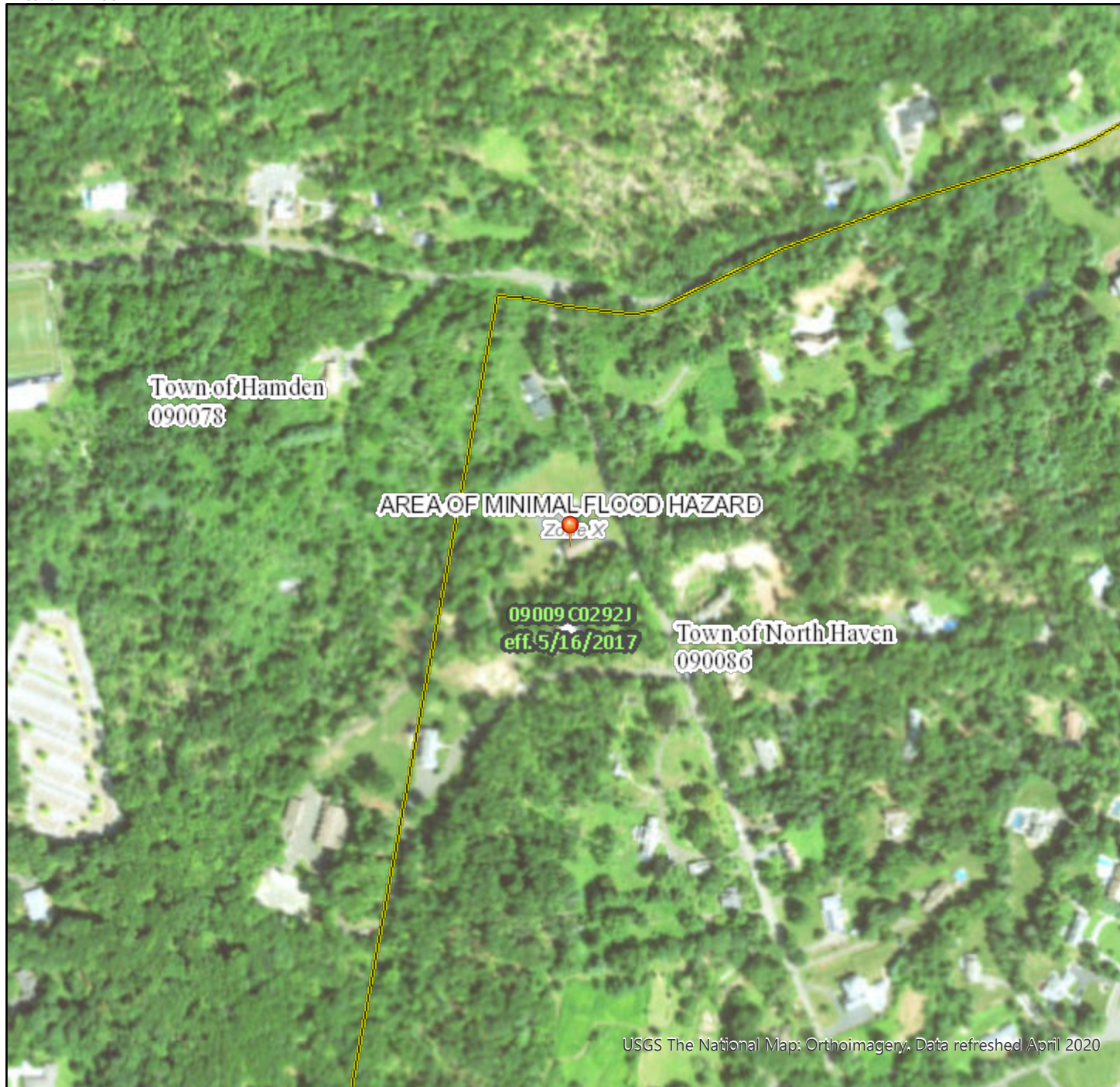

Legend

SEE FIS REPORT FOR DETAILED LEGEND AND INDEX MAP FOR FIRM PANEL LAYOUT

SPECIAL FLOOD HAZARD AREAS		Without Base Flood Elevation (BFE) <i>Zone A, V, A99</i>
		With BFE or Depth <i>Zone AE, AO, AH, VE, AR</i>
		Regulatory Floodway

OTHER AREAS OF FLOOD HAZARD		0.2% Annual Chance Flood Hazard, Areas of 1% annual chance flood with average depth less than one foot or with drainage areas of less than one square mile <i>Zone X</i>
		Future Conditions 1% Annual Chance Flood Hazard <i>Zone X</i>
		Area with Reduced Flood Risk due to Levee. See Notes. <i>Zone X</i>
		Area with Flood Risk due to Levee <i>Zone D</i>

OTHER AREAS		NO SCREEN Area of Minimal Flood Hazard <i>Zone X</i>
		Effective LOMRs
		Area of Undetermined Flood Hazard <i>Zone D</i>

GENERAL STRUCTURES		Channel, Culvert, or Storm Sewer
		Levee, Dike, or Floodwall

OTHER FEATURES		20.2 Cross Sections with 1% Annual Chance Water Surface Elevation
		17.5 Cross Sections with 1% Annual Chance Water Surface Elevation
		Coastal Transect
		Base Flood Elevation Line (BFE)
		Limit of Study
		Jurisdiction Boundary

MAP PANELS		Digital Data Available
		No Digital Data Available
		Unmapped

The pin displayed on the map is an approximate point selected by the user and does not represent an authoritative property location.

This map complies with FEMA's standards for the use of digital flood maps if it is not void as described below. The basemap shown complies with FEMA's basemap accuracy standards.

The flood hazard information is derived directly from the authoritative NFHL web services provided by FEMA. This map was exported on **10/9/2020 at 12:33 PM** and does not reflect changes or amendments subsequent to this date and time. The NFHL and effective information may change or become superseded by new data over time.

This map image is void if the one or more of the following map elements do not appear: basemap imagery, flood zone labels, legend, scale bar, map creation date, community identifiers, FIRM panel number, and FIRM effective date. Map images for unmapped and unmodernized areas cannot be used for regulatory purposes.



USGS The National Map: Orthoimagery. Data refreshed April 2020

ATTACHMENT C

NATURAL RESOURCES CONSERVATION SERVICE HYDROLOGIC SOIL GROUP MAP

Hydrologic Soil Group—State of Connecticut

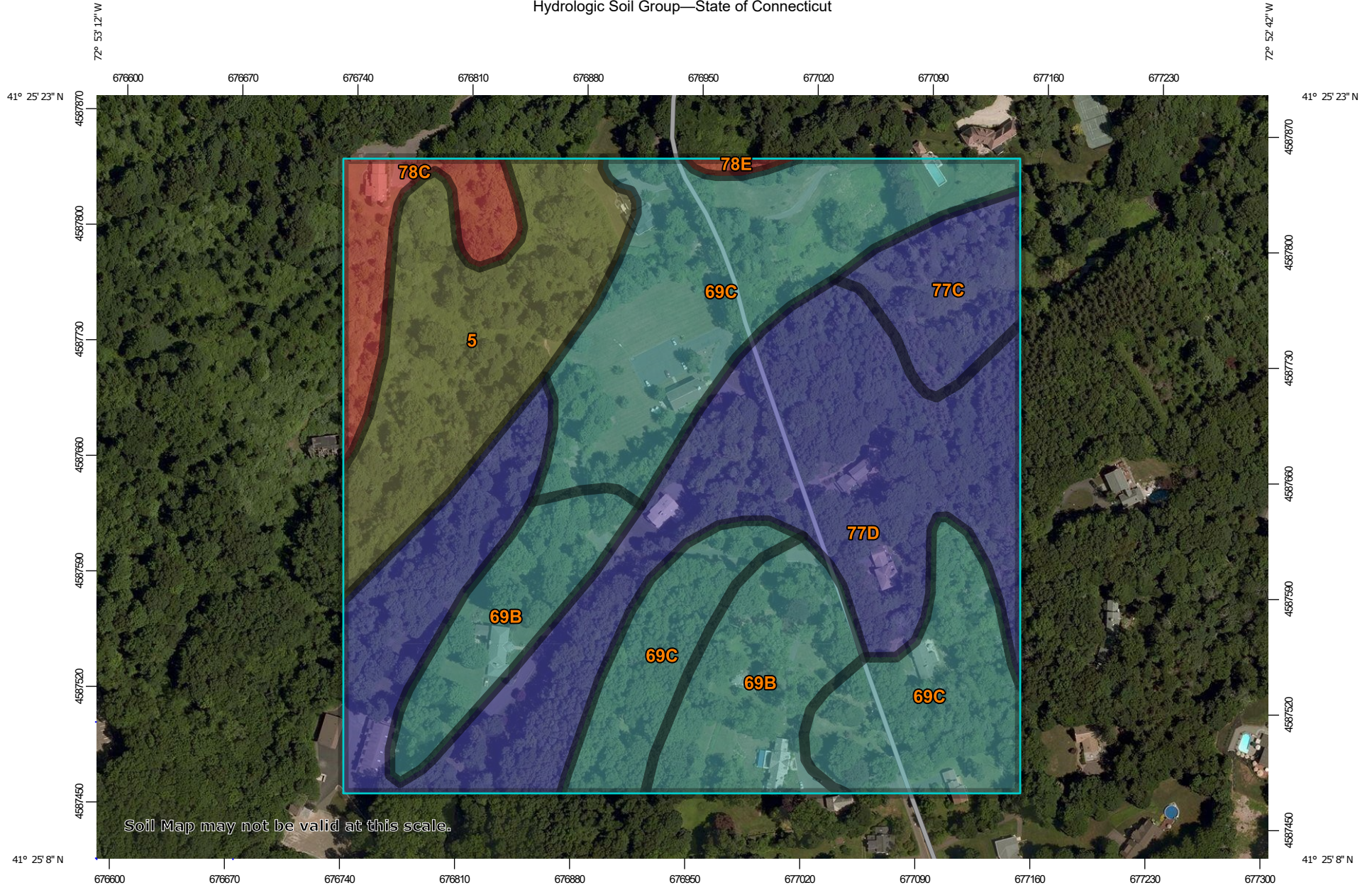

Map Scale: 1:3,260 if printed on A landscape (11" x 8.5") sheet.

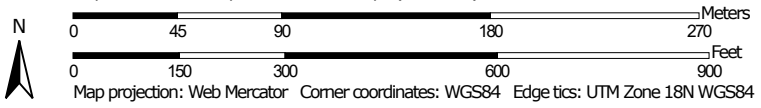

MAP LEGEND

Area of Interest (AOI)

 Area of Interest (AOI)

Soils

Soil Rating Polygons

 A
 A/D
 B
 B/D
 C
 C/D
 D
 Not rated or not available

Soil Rating Lines

 A
 A/D
 B
 B/D
 C
 C/D
 D
 Not rated or not available

Soil Rating Points

 A
 A/D
 B
 B/D

 C
 C/D
 D
 Not rated or not available

Water Features

 Streams and Canals

Transportation

 Rails
 Interstate Highways
 US Routes
 Major Roads
 Local Roads

Background

 Aerial Photography

MAP INFORMATION

The soil surveys that comprise your AOI were mapped at 1:12,000.

Warning: Soil Map may not be valid at this scale.

Enlargement of maps beyond the scale of mapping can cause misunderstanding of the detail of mapping and accuracy of soil line placement. The maps do not show the small areas of contrasting soils that could have been shown at a more detailed scale.

Please rely on the bar scale on each map sheet for map measurements.

Source of Map: Natural Resources Conservation Service
 Web Soil Survey URL:
 Coordinate System: Web Mercator (EPSG:3857)

Maps from the Web Soil Survey are based on the Web Mercator projection, which preserves direction and shape but distorts distance and area. A projection that preserves area, such as the Albers equal-area conic projection, should be used if more accurate calculations of distance or area are required.

This product is generated from the USDA-NRCS certified data as of the version date(s) listed below.

Soil Survey Area: State of Connecticut
 Survey Area Data: Version 19, Sep 13, 2019

Soil map units are labeled (as space allows) for map scales 1:50,000 or larger.

Date(s) aerial images were photographed: Jun 27, 2014—Jul 22, 2014

The orthophoto or other base map on which the soil lines were compiled and digitized probably differs from the background imagery displayed on these maps. As a result, some minor shifting of map unit boundaries may be evident.

Hydrologic Soil Group

Map unit symbol	Map unit name	Rating	Acres in AOI	Percent of AOI
5	Wilbraham silt loam, 0 to 3 percent slopes	C/D	5.5	14.1%
69B	Yalesville fine sandy loam, 3 to 8 percent slopes	C	5.5	13.9%
69C	Yalesville fine sandy loam, 8 to 15 percent slopes	C	12.0	30.5%
77C	Cheshire-Holyoke complex, 3 to 15 percent slopes, very rocky	B	2.0	5.1%
77D	Cheshire-Holyoke complex, 15 to 35 percent slopes, very rocky	B	12.4	31.5%
78C	Holyoke-Rock outcrop complex, 3 to 15 percent slopes	D	1.8	4.6%
78E	Holyoke-Rock outcrop complex, 15 to 45 percent slopes	D	0.1	0.3%
Totals for Area of Interest			39.3	100.0%

Description

Hydrologic soil groups are based on estimates of runoff potential. Soils are assigned to one of four groups according to the rate of water infiltration when the soils are not protected by vegetation, are thoroughly wet, and receive precipitation from long-duration storms.

The soils in the United States are assigned to four groups (A, B, C, and D) and three dual classes (A/D, B/D, and C/D). The groups are defined as follows:

Group A. Soils having a high infiltration rate (low runoff potential) when thoroughly wet. These consist mainly of deep, well drained to excessively drained sands or gravelly sands. These soils have a high rate of water transmission.

Group B. Soils having a moderate infiltration rate when thoroughly wet. These consist chiefly of moderately deep or deep, moderately well drained or well drained soils that have moderately fine texture to moderately coarse texture. These soils have a moderate rate of water transmission.

Group C. Soils having a slow infiltration rate when thoroughly wet. These consist chiefly of soils having a layer that impedes the downward movement of water or soils of moderately fine texture or fine texture. These soils have a slow rate of water transmission.

Group D. Soils having a very slow infiltration rate (high runoff potential) when thoroughly wet. These consist chiefly of clays that have a high shrink-swell potential, soils that have a high water table, soils that have a claypan or clay layer at or near the surface, and soils that are shallow over nearly impervious material. These soils have a very slow rate of water transmission.

If a soil is assigned to a dual hydrologic group (A/D, B/D, or C/D), the first letter is for drained areas and the second is for undrained areas. Only the soils that in their natural condition are in group D are assigned to dual classes.

Rating Options

Aggregation Method: Dominant Condition

Component Percent Cutoff: None Specified

Tie-break Rule: Higher

ATTACHMENT D
STORM DRAINAGE COMPUTATIONS

Rational Method Individual Basin Calculations

Project: Slate Upper School
 Location: 5100 Ridge Road, North Haven, CT

By: AWG
 Rev. MCB

Date: 10/23/20
 Date: 2/16/21

Basin Name	Impervious Area C=0.9 (sf)	Grassed Area C=0.3 (sf)	Wooded Area C=0.2 (sf)	Total Area (sf)	Total Area (ac)	Weighted C	Tc (min)
System 110							
AD 6	2053	4579	0	6632	0.15	0.49	5.0
AD 7	896	679	0	1575	0.04	0.64	5.0
MH 8	702	0	0	702	0.02	0.90	5.0
AD 9	941	375	0	1316	0.03	0.73	5.0
AD 11	845	318	0	1163	0.03	0.74	5.0
AD 12	3381	539	0	3920	0.09	0.82	5.0
AD 14	1758	1456	0	3214	0.07	0.63	5.0
AD 15	422	3405	0	3827	0.09	0.37	5.0
CLCB 16	2362	0	0	2362	0.05	0.90	5.0
AD 22	95	83	0	178	0.004	0.62	5.0
AD 23	79	199	0	278	0.01	0.47	5.0
System 120							
CCB 19	5108	201	0	5309	0.12	0.88	5.0
CCB 20	11155	7454	16334	34943	0.80	0.44	12.5
CCB 21	4385	415	0	4837	0.11	0.84	5.0
CCB 22	3686	3211	5458	12355	0.28	0.43	5.0
Outlet System 100/120							
AD 25	0	3818	2076	5894	0.14	0.26	5.0
AD 28	0	1373	1650	3023	0.07	0.25	5.0
AD 29	2843	7792	21550	32185	0.74	0.29	10.0
AD 30	4893	6834	20975	32702	0.75	0.33	12.5

Rational Method Roof Drain System Calculations

Project: Slate Upper School
Location: 5100 Ridge Road, North Haven, CT

By: MCB
Checked: _____

Date: 2/16/21
Date: _____

Total Roof Runoff to Proposed Storm Drainage System (In Hydraflow Model)

	Roof to AD 9	Roof to AD 14
C	0.90	0.90
I	9.14	9.14
A	0.06	0.08
Q	0.48	0.65

Time of Concentration (T_c) or Travel Time (T_t) Worksheet

Project: Slate Upper School By: FAB Date: 10/27/20
 Location: 5100 Ridge Road, North Haven, CT Checked: _____ Date: _____
 Circle one: Present Developed Watershed: CCB 20
 Circle one: T_c T_t Subwatershed: _____

Sheet flow (applicable to T_c only)

	Segment ID	A-B	
1. Surface description (Table 3-1)		WOODS	
2. Manning's roughness coeff. for sheet flow, n (Table 3-1)		0.400	
3. Flow Length, L (< 300ft)	ft.	65.0	
4. Two-year 24-hr rainfall, P_2	in.	3.50	
5. Land slope, s	ft./ft.	0.045	
6. $T_t = \frac{0.007 (nL)^{0.8}}{P_2^{0.5} (s^{0.4})}$	hr.	0.175	= 0.175

Shallow concentrated flow (assume hyd. radius = depth of flow)

	Segment ID	B-C	C-D	D-E	E-F	F-G	
7. Surface description		WOODS	BIT	WOODS	GRASS	BIT	
8. Manning's roughness coeff., n		0.100	0.015	0.100	0.080	0.015	
9. Paved or unpaved		UNPVD	PVD	UNPVD	UNPVD	PVD	
10. Depth of flow, d (default values: d=.4 unpaved, d=.2 paved) ft.		0.40	0.20	0.40	0.40	0.20	
11. Flow Length, L	ft.	270.0	38.0	25.0	40.0	100.0	
12. Watercourse slope, s	ft./ft.	0.17	0.16	0.16	0.20	0.03	
13. Average velocity, $V = \frac{1.49}{n} (d^{2/3})(s^{1/2})$	fps.	3.34	13.59	3.24	4.52	5.88	
14. $T_t = \frac{L}{3600 * V}$	hr.	0.022	0.001	0.002	0.002	0.005	= 0.033

Channel flow

	Segment ID					
15. Channel Bottom width, b	ft.					
16. Horizontal side slope component, z (z horiz:1 vert)	ft.					
17. Depth of flow, d	ft.					
18. Cross sectional flow area, A (assume trapazoidal)	ft. ²					
19. Wetted perimeter, P_w	ft.					
20. Hydraulic Radius, $R = \frac{A}{P_w}$	ft.					
21. Channel slope, s	ft./ft.					
22. Manning's roughness coeff., n						
23. $V = \frac{1.49}{n} (R^{2/3})(s^{1/2})$	fps.					
24. Flow length, L	ft.					
25. $T_t = \frac{L}{3600 * V}$	hr.					0.000
26. Watershed or subarea T_c or T_t (add T_t in steps 6, 14 & 25)	hr.					0.208

Time of Concentration (T_c) or Travel Time (T_t) Worksheet

Project: Slate Upper School By: FAB Date: Rev. 12/4/20
 Location: 5100 Ridge Road, North Haven, CT Checked: _____ Date: _____
 Circle one: Present Developed Watershed: AD 30
 Circle one: T_c T_t Subwatershed: _____

Sheet flow (applicable to T_c only)

	Segment ID	A-B
1. Surface description (Table 3-1)		WOODS
2. Manning's roughness coeff. for sheet flow, n (Table 3-1)		0.400
3. Flow Length, L (< 300ft)	ft.	70.0
4. Two-year 24-hr rainfall, P_2	in.	3.50
5. Land slope, s	ft./ft.	0.045
6. $T_t = \frac{0.007 (nL)^{0.8}}{P_2^{0.5} (s^{0.4})}$	hr.	0.186 = 0.186

Shallow concentrated flow (assume hyd. radius = depth of flow)

	Segment ID	B-C	C-D	D-E	E-F
7. Surface description		WOODS	BIT	WOODS	GRASS
8. Manning's roughness coeff., n		0.100	0.015	0.100	0.080
9. Paved or unpaved		UNPVD	PVD	UNPVD	UNPVD
10. Depth of flow, d (default values: d=.4 unpaved, d=.2 paved) ft.		0.40	0.20	0.40	0.40
11. Flow Length, L	ft.	210.0	101.0	25.0	10.0
12. Watercourse slope, s	ft./ft.	0.15	0.16	0.16	0.30
13. Average velocity, $V = \frac{1.49}{n} (d^{2/3})(s^{1/2})$	fps.	3.13	13.59	3.24	5.54
14. $T_t = \frac{L}{3600 * V}$	hr.	0.019	+ 0.002	+ 0.002	+ 0.001 = 0.023

Channel flow

	Segment ID				
15. Channel Bottom width, b	ft.				
16. Horizontal side slope component, z (z horiz:1 vert)	ft.				
17. Depth of flow, d	ft.				
18. Cross sectional flow area, A (assume trapazoidal)	ft. ²				
19. Wetted perimeter, P_w	ft.				
20. Hydraulic Radius, $R = \frac{A}{P_w}$	ft.				
21. Channel slope, s	ft./ft.				
22. Manning's roughness coeff., n					
23. $V = \frac{1.49}{n} (R^{2/3})(s^{1/2})$	fps.				
24. Flow length, L	ft.				
25. $T_t = \frac{L}{3600 * V}$	hr.				
26. Watershed or subarea T_c or T_t (add T_t in steps 6, 14 & 25)	hr.				+ 0.000 = 0.209



NOAA Atlas 14, Volume 10, Version 3
Location name: North Haven, Connecticut, USA*
Latitude: 41.4214°, Longitude: -72.8826°
Elevation: 181.97 ft**



* source: ESRI Maps
 ** source: USGS

POINT PRECIPITATION FREQUENCY ESTIMATES

Sanja Perica, Sandra Pavlovic, Michael St. Laurent, Carl Trypaluk, Dale Unruh, Orlan Wilhite

NOAA, National Weather Service, Silver Spring, Maryland

[PF tabular](#) | [PF graphical](#) | [Maps & aerials](#)

PF tabular

PDS-based point precipitation frequency estimates with 90% confidence intervals (in inches/hour)¹										
Duration	Average recurrence interval (years)									
	1	2	5	10	25	50	100	200	500	1000
5-min	4.09 (3.14-5.15)	4.96 (3.80-6.24)	6.37 (4.86-8.05)	7.54 (5.72-9.59)	9.14 (6.74-12.2)	10.3 (7.50-14.2)	11.6 (8.21-16.6)	13.1 (8.76-19.1)	15.2 (9.82-23.1)	16.9 (10.7-26.3)
10-min	2.90 (2.23-3.65)	3.51 (2.69-4.42)	4.51 (3.44-5.71)	5.33 (4.06-6.79)	6.47 (4.78-8.66)	7.33 (5.31-10.0)	8.23 (5.81-11.8)	9.25 (6.20-13.5)	10.7 (6.95-16.3)	12.0 (7.57-18.6)
15-min	2.28 (1.74-2.86)	2.75 (2.11-3.47)	3.53 (2.70-4.46)	4.18 (3.18-5.32)	5.08 (3.75-6.79)	5.74 (4.17-7.88)	6.45 (4.56-9.22)	7.26 (4.86-10.6)	8.42 (5.45-12.8)	9.38 (5.94-14.6)
30-min	1.58 (1.21-1.99)	1.91 (1.46-2.40)	2.44 (1.87-3.09)	2.89 (2.20-3.68)	3.50 (2.59-4.69)	3.96 (2.87-5.43)	4.45 (3.15-6.36)	5.01 (3.35-7.33)	5.81 (3.76-8.85)	6.48 (4.10-10.1)
60-min	1.01 (0.775-1.27)	1.22 (0.935-1.54)	1.56 (1.19-1.97)	1.85 (1.40-2.35)	2.24 (1.65-2.99)	2.53 (1.83-3.47)	2.84 (2.01-4.06)	3.19 (2.14-4.67)	3.71 (2.40-5.64)	4.13 (2.62-6.44)
2-hr	0.666 (0.514-0.832)	0.795 (0.614-0.994)	1.01 (0.774-1.26)	1.18 (0.905-1.50)	1.42 (1.06-1.89)	1.61 (1.17-2.19)	1.80 (1.28-2.55)	2.02 (1.36-2.94)	2.34 (1.52-3.54)	2.61 (1.66-4.04)
3-hr	0.515 (0.400-0.641)	0.614 (0.476-0.765)	0.776 (0.599-0.970)	0.910 (0.699-1.15)	1.10 (0.817-1.45)	1.23 (0.902-1.67)	1.38 (0.984-1.95)	1.55 (1.05-2.25)	1.80 (1.17-2.71)	2.01 (1.27-3.09)
6-hr	0.328 (0.257-0.406)	0.392 (0.306-0.486)	0.497 (0.387-0.618)	0.584 (0.452-0.730)	0.704 (0.528-0.926)	0.793 (0.584-1.07)	0.888 (0.638-1.25)	1.00 (0.677-1.44)	1.17 (0.761-1.75)	1.31 (0.832-2.00)
12-hr	0.202 (0.158-0.247)	0.243 (0.191-0.299)	0.312 (0.244-0.385)	0.369 (0.287-0.458)	0.447 (0.338-0.585)	0.505 (0.374-0.678)	0.567 (0.410-0.797)	0.642 (0.436-0.918)	0.754 (0.494-1.12)	0.850 (0.544-1.29)
24-hr	0.119 (0.094-0.145)	0.146 (0.115-0.178)	0.190 (0.150-0.233)	0.227 (0.178-0.279)	0.277 (0.211-0.361)	0.314 (0.235-0.421)	0.355 (0.259-0.498)	0.405 (0.276-0.575)	0.482 (0.316-0.712)	0.549 (0.352-0.829)
2-day	0.067 (0.053-0.081)	0.083 (0.066-0.101)	0.111 (0.088-0.135)	0.133 (0.105-0.163)	0.164 (0.126-0.213)	0.187 (0.141-0.250)	0.212 (0.156-0.298)	0.244 (0.167-0.345)	0.295 (0.194-0.434)	0.340 (0.219-0.510)
3-day	0.048 (0.039-0.058)	0.061 (0.048-0.073)	0.081 (0.064-0.098)	0.097 (0.077-0.118)	0.120 (0.092-0.155)	0.136 (0.103-0.182)	0.155 (0.115-0.217)	0.179 (0.123-0.252)	0.217 (0.143-0.318)	0.251 (0.162-0.375)
4-day	0.039 (0.031-0.047)	0.049 (0.039-0.059)	0.065 (0.052-0.078)	0.078 (0.062-0.095)	0.096 (0.074-0.124)	0.109 (0.083-0.145)	0.124 (0.092-0.173)	0.143 (0.098-0.201)	0.173 (0.114-0.253)	0.200 (0.129-0.298)
7-day	0.027 (0.021-0.032)	0.033 (0.026-0.039)	0.043 (0.034-0.051)	0.051 (0.041-0.062)	0.063 (0.049-0.080)	0.071 (0.054-0.094)	0.080 (0.060-0.111)	0.092 (0.063-0.128)	0.111 (0.073-0.160)	0.127 (0.082-0.188)
10-day	0.022 (0.017-0.026)	0.026 (0.021-0.031)	0.034 (0.027-0.040)	0.040 (0.032-0.048)	0.048 (0.037-0.061)	0.054 (0.041-0.071)	0.061 (0.045-0.084)	0.070 (0.048-0.097)	0.083 (0.055-0.119)	0.094 (0.061-0.139)
20-day	0.015 (0.013-0.018)	0.018 (0.015-0.021)	0.022 (0.018-0.026)	0.025 (0.020-0.030)	0.030 (0.023-0.037)	0.033 (0.025-0.043)	0.037 (0.027-0.049)	0.041 (0.028-0.056)	0.047 (0.031-0.067)	0.052 (0.034-0.076)
30-day	0.013 (0.011-0.015)	0.015 (0.012-0.017)	0.017 (0.014-0.020)	0.020 (0.016-0.023)	0.023 (0.018-0.028)	0.025 (0.019-0.032)	0.028 (0.020-0.036)	0.030 (0.021-0.041)	0.034 (0.023-0.048)	0.037 (0.024-0.054)
45-day	0.011 (0.009-0.013)	0.012 (0.010-0.014)	0.014 (0.011-0.016)	0.015 (0.012-0.018)	0.017 (0.014-0.022)	0.019 (0.015-0.024)	0.021 (0.015-0.027)	0.022 (0.016-0.031)	0.025 (0.017-0.035)	0.026 (0.017-0.038)
60-day	0.009 (0.008-0.011)	0.010 (0.008-0.012)	0.012 (0.010-0.014)	0.013 (0.011-0.015)	0.015 (0.011-0.018)	0.016 (0.012-0.020)	0.017 (0.013-0.022)	0.018 (0.013-0.025)	0.020 (0.013-0.028)	0.021 (0.014-0.030)

¹ Precipitation frequency (PF) estimates in this table are based on frequency analysis of partial duration series (PDS). Numbers in parenthesis are PF estimates at lower and upper bounds of the 90% confidence interval. The probability that precipitation frequency estimates (for a given duration and average recurrence interval) will be greater than the upper bound (or less than the lower bound) is 5%. Estimates at upper bounds are not checked against probable maximum precipitation (PMP) estimates and may be higher than currently valid PMP values. Please refer to NOAA Atlas 14 document for more information.

[Back to Top](#)

PF graphical

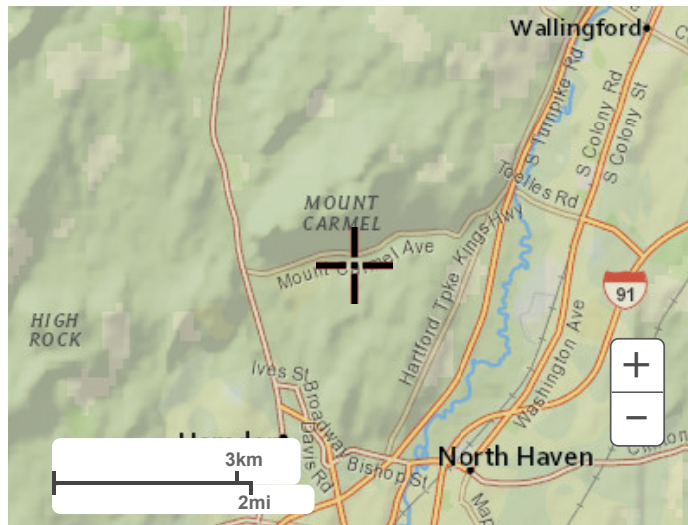

Large scale terrain



Large scale map

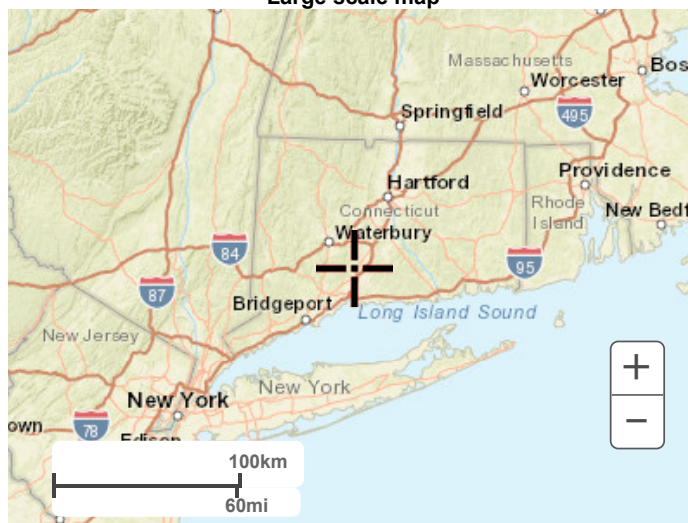

Large scale aerial

Storm Sewer IDF Curves

IDF file: North Haven.IDF

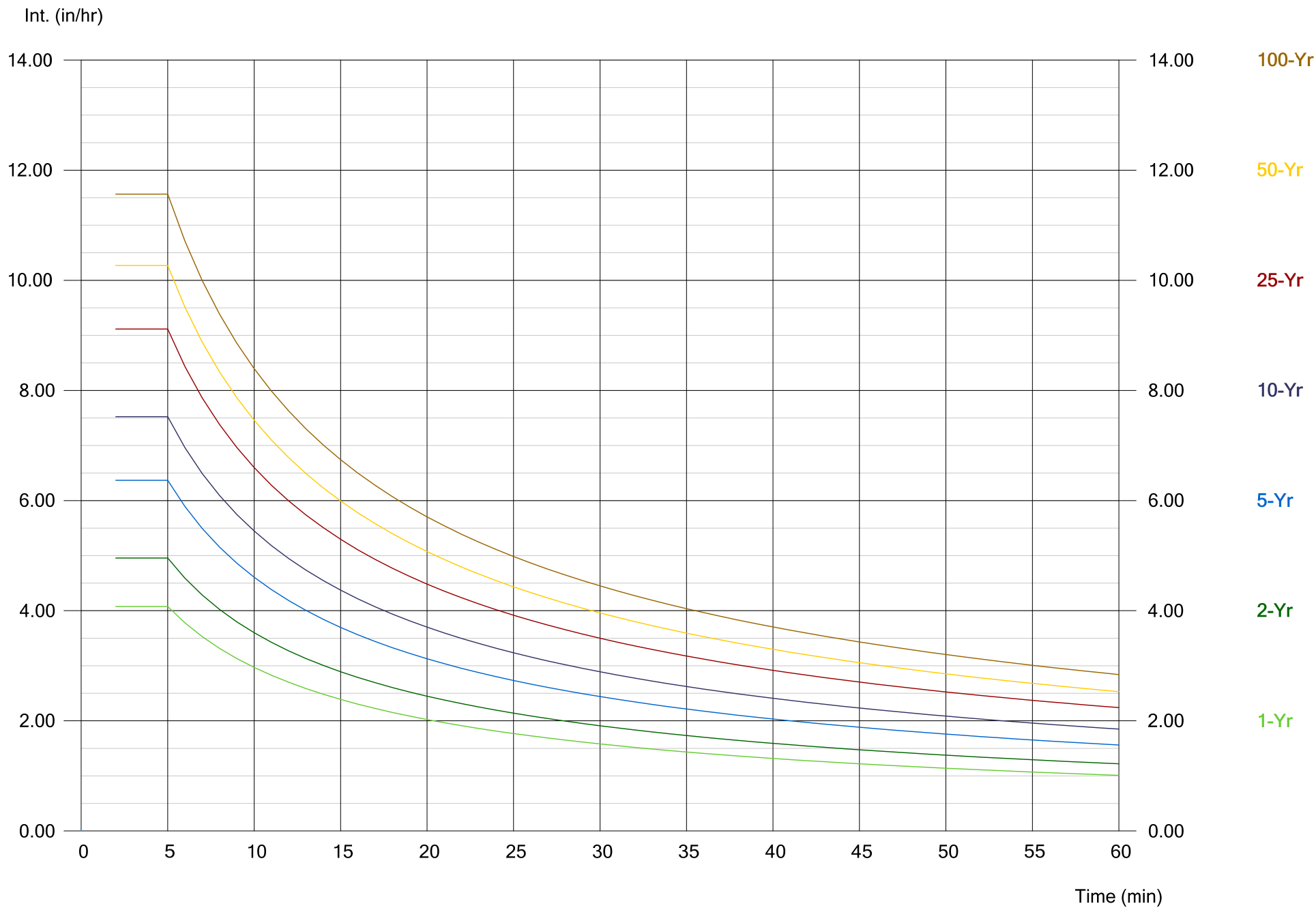

Hydraflow Storm Sewers Extension for Autodesk® AutoCAD® Civil 3D® Plan

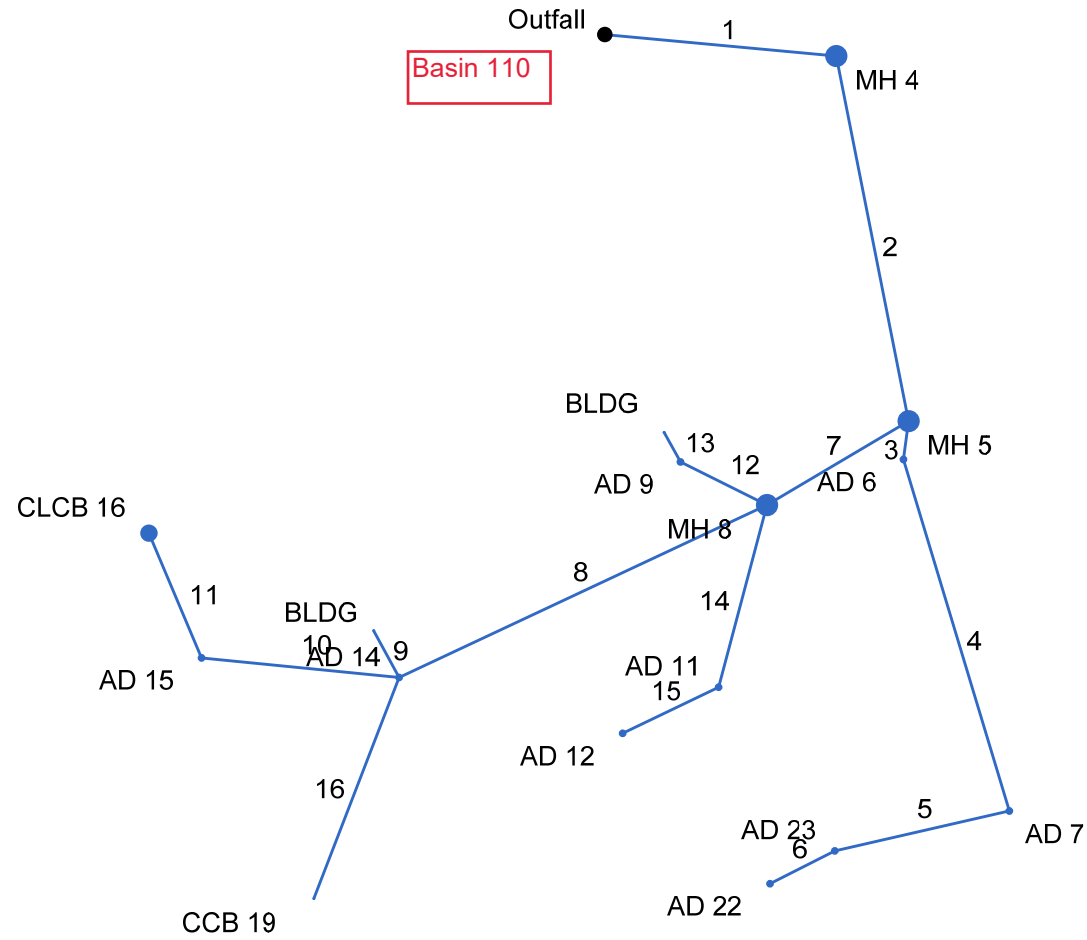

Basin 110

25-Year

Storm Sewer Inventory Report

Line No.	Alignment				Flow Data				Physical Data								Line ID
	Dnstr Line No.	Line Length (ft)	Defl angle (deg)	Junc Type	Known Q (cfs)	Drng Area (ac)	Runoff Coeff (C)	Inlet Time (min)	Invert El Dn (ft)	Line Slope (%)	Invert El Up (ft)	Line Size (in)	Line Shape	N Value (n)	J-Loss Coeff (K)	Inlet/ Rim El (ft)	
1	End	48.000	5.289	MH	0.00	0.00	0.00	0.0	156.00	2.08	157.00	15	Cir	0.012	0.97	165.50	FES 3 - MH 4
2	1	77.000	73.535	MH	0.00	0.00	0.00	0.0	160.00	5.84	164.50	12	Cir	0.012	0.95	172.80	MH 4 - MH 5
3	2	8.000	18.694	DrGrt	0.00	0.16	0.51	5.0	169.00	5.00	169.40	12	Cir	0.012	0.70	172.60	MH 5 - AD 6
4	3	76.000	-24.256	DrGrt	0.00	0.04	0.64	5.0	169.40	4.74	173.00	12	Cir	0.012	1.50	183.60	AD 6 - AD 7
5	4	37.000	93.851	DrGrt	0.00	0.01	0.47	5.0	173.00	1.08	173.40	6	Cir	0.012	0.50	175.80	AD 7 - AD 23
6	5	15.000	-14.138	DrGrt	0.00	0.01	0.62	5.0	173.40	0.67	173.50	6	Cir	0.012	1.00	175.80	AD 23 - AD 22
7	2	34.000	70.359	MH	0.00	0.02	0.90	0.0	164.50	3.53	165.70	12	Cir	0.012	0.87	173.40	MH 5 - MH 8
8	7	84.000	5.683	DrGrt	0.00	0.07	0.63	5.0	165.70	1.67	167.10	12	Cir	0.012	1.92	171.50	MH 8 - AD 14
9	8	11.000	86.880	None	0.65	0.00	0.00	0.0	169.00	1.82	169.20	6	Cir	0.012	1.00	173.50	AD 14 - BLDG
10	8	41.000	30.830	DrGrt	0.00	0.09	0.37	5.0	167.10	6.59	169.80	12	Cir	0.012	1.35	172.50	AD 14 - AD 15
11	10	28.000	61.412	Grate	0.00	0.05	0.90	5.0	169.80	0.71	170.00	12	Cir	0.012	1.00	173.30	AD 15 - CLCB 16
12	7	20.000	57.412	DrGrt	0.00	0.03	0.73	5.0	169.00	1.50	169.30	8	Cir	0.012	0.92	173.20	MH 8 - AD 9
13	12	7.000	34.156	None	0.48	0.00	0.00	0.0	169.50	1.43	169.60	6	Cir	0.012	1.00	173.30	AD 9 - BLDG
14	7	39.000	-44.320	DrGrt	0.00	0.03	0.74	5.0	169.00	1.79	169.70	8	Cir	0.012	1.20	173.30	MH 8 - AD 11
15	14	22.000	49.463	DrGrt	0.00	0.09	0.82	5.0	169.70	2.27	170.20	8	Cir	0.012	1.00	173.60	AD 11 - AD 12
16	8	49.000	-43.798	None	2.06	0.00	0.00	0.0	168.80	8.98	173.20	8	Cir	0.012	1.00	177.80	AD 14 - CCB 19

Project File: System 110.stm

Number of lines: 16

Date: 2/16/2021

Storm Sewer Tabulation

Station		Len (ft)	Drng Area		Rnoff coeff (C)	Area x C		Tc		Rain (l) (in/hr)	Total flow (cfs)	Cap full (cfs)	Vel (ft/s)	Pipe		Invert Elev		HGL Elev		Grnd / Rim Elev		Line ID
Line	To Line		Incr (ac)	Total (ac)		Incr	Total	Inlet (min)	Syst (min)					Size (in)	Slope (%)	Dn (ft)	Up (ft)	Dn (ft)	Up (ft)	Dn (ft)	Up (ft)	
1	End	48.000	0.00	0.60	0.00	0.00	0.38	0.0	6.5	8.1	6.25	10.10	5.49	15	2.08	156.00	157.00	157.72	158.01	157.36	165.50	FES 3 - MH 4
2	1	77.000	0.00	0.60	0.00	0.00	0.38	0.0	6.4	8.2	6.28	9.33	10.42	12	5.84	160.00	164.50	160.60	165.46	165.50	172.80	MH 4 - MH 5
3	2	8.000	0.16	0.22	0.51	0.08	0.12	5.0	6.4	8.2	0.97	8.63	5.21	12	5.00	169.00	169.40	169.23	169.81	172.80	172.60	MH 5 - AD 6
4	3	76.000	0.04	0.06	0.64	0.03	0.04	5.0	5.6	8.7	0.32	8.40	1.67	12	4.74	169.40	173.00	169.81	173.23	172.60	183.60	AD 6 - AD 7
5	4	37.000	0.01	0.02	0.47	0.00	0.01	5.0	5.2	9.0	0.10	0.63	1.50	6	1.08	173.00	173.40	173.23	173.55	183.60	175.80	AD 7 - AD 23
6	5	15.000	0.01	0.01	0.62	0.01	0.01	5.0	5.0	9.1	0.06	0.50	1.36	6	0.67	173.40	173.50	173.55	173.62	175.80	175.80	AD 23 - AD 22
7	2	34.000	0.02	0.38	0.90	0.02	0.26	0.0	5.8	8.5	5.39	7.25	7.01	12	3.53	164.50	165.70	165.46	166.63	172.80	173.40	MH 5 - MH 8
8	7	84.000	0.07	0.21	0.63	0.04	0.12	5.0	5.6	8.7	3.78	4.98	5.19	12	1.67	165.70	167.10	166.63	167.93	173.40	171.50	MH 8 - AD 14
9	8	11.000	0.00	0.00	0.00	0.00	0.00	0.0	0.0	0.0	0.65	0.82	4.21	6	1.82	169.00	169.20	169.34	169.61	171.50	173.50	AD 14 - BLDG
10	8	41.000	0.09	0.14	0.37	0.03	0.08	5.0	5.2	9.0	0.70	9.90	1.94	12	6.59	167.10	169.80	167.93	170.15	171.50	172.50	AD 14 - AD 15
11	10	28.000	0.05	0.05	0.90	0.05	0.05	5.0	5.0	9.1	0.41	3.26	2.07	12	0.71	169.80	170.00	170.15	170.26	172.50	173.30	AD 15 - CLCB 16
12	7	20.000	0.03	0.03	0.73	0.02	0.02	5.0	5.0	9.1	0.68	1.60	3.81	8	1.50	169.00	169.30	169.30	169.69	173.40	173.20	MH 8 - AD 9
13	12	7.000	0.00	0.00	0.00	0.00	0.00	0.0	0.0	0.0	0.48	0.73	3.60	6	1.43	169.50	169.60	169.80	169.95	173.20	173.30	AD 9 - BLDG
14	7	39.000	0.03	0.12	0.74	0.02	0.10	5.0	5.1	9.0	0.87	1.75	4.27	8	1.79	169.00	169.70	169.33	170.14	173.40	173.30	MH 8 - AD 11
15	14	22.000	0.09	0.09	0.82	0.07	0.07	5.0	5.0	9.1	0.67	1.97	2.98	8	2.27	169.70	170.20	170.14	170.59	173.30	173.60	AD 11 - AD 12
16	8	49.000	0.00	0.00	0.00	0.00	0.00	0.0	0.0	0.0	2.06	3.92	8.70	8	8.98	168.80	173.20	169.14	173.83	171.50	177.80	AD 14 - CCB 19

Project File: System 110.stm

Number of lines: 16

Run Date: 2/16/2021

NOTES: Intensity = 40.58 / (Inlet time + 3.50) ^ 0.70; Return period = Yrs. 25 ; c = cir e = ellip b = box

Hydraulic Grade Line Computations

Line	Size (in)	Q (cfs)	Downstream								Len (ft)	Upstream								Check		JL coeff (K)	Minor loss (ft)
			Invert elev (ft)	HGL elev (ft)	Depth (ft)	Area (sqft)	Vel (ft/s)	Vel head (ft)	EGL elev (ft)	Sf (%)		Invert elev (ft)	HGL elev (ft)	Depth (ft)	Area (sqft)	Vel (ft/s)	Vel head (ft)	EGL elev (ft)	Sf (%)	Ave Sf (%)	Enrgy loss (ft)		
1	15	6.25	156.00	157.72	1.25	1.06	5.10	0.40	158.12	0.799	48.000	157.00	158.01	1.01**	1.06	5.88	0.54	158.55	0.819	0.809	0.388	0.97	0.52
2	12	6.28	160.00	160.60	0.60*	0.49	12.74	1.02	161.62	0.000	77.000	164.50	165.46	0.96**	0.78	8.09	1.02	166.48	0.000	0.000	n/a	0.95	0.97
3	12	0.97	169.00	169.23	0.23*	0.13	7.26	0.16	169.38	0.000	8.000	169.40	169.81	0.41**	0.31	3.17	0.16	169.97	0.000	0.000	n/a	0.70	n/a
4	12	0.32	169.40	169.81	0.41	0.14	1.04	0.08	169.90	0.000	76.000	173.00	173.23 j	0.23**	0.14	2.30	0.08	173.31	0.000	0.000	n/a	1.50	0.12
5	6	0.10	173.00	173.23	0.23	0.05	1.10	0.06	173.29	0.000	37.000	173.40	173.55 j	0.15**	0.05	1.90	0.06	173.61	0.000	0.000	n/a	0.50	n/a
6	6	0.06	173.40	173.55	0.15	0.03	1.10	0.04	173.60	0.000	15.000	173.50	173.62 j	0.12**	0.03	1.63	0.04	173.66	0.000	0.000	n/a	1.00	0.04
7	12	5.39	164.50	165.46	0.96	0.76	6.95	0.78	166.24	0.000	34.000	165.70	166.63 j	0.93**	0.76	7.06	0.78	167.41	0.000	0.000	n/a	0.87	n/a
8	12	3.78	165.70	166.63	0.93	0.69	4.94	0.46	167.09	0.000	84.000	167.10	167.93 j	0.83**	0.69	5.44	0.46	168.39	0.000	0.000	n/a	1.92	n/a
9	6	0.65	169.00	169.34	0.34*	0.14	4.63	0.22	169.56	0.000	11.000	169.20	169.61	0.41**	0.17	3.79	0.22	169.83	0.000	0.000	n/a	1.00	n/a
10	12	0.70	167.10	167.93	0.83	0.24	1.01	0.13	168.05	0.000	41.000	169.80	170.15 j	0.35**	0.24	2.87	0.13	170.28	0.000	0.000	n/a	1.35	n/a
11	12	0.41	169.80	170.15	0.35	0.17	1.68	0.09	170.24	0.000	28.000	170.00	170.26 j	0.26**	0.17	2.47	0.09	170.36	0.000	0.000	n/a	1.00	n/a
12	8	0.68	169.00	169.30	0.30*	0.15	4.40	0.16	169.46	0.000	20.000	169.30	169.69	0.39**	0.21	3.22	0.16	169.85	0.000	0.000	n/a	0.92	0.15
13	6	0.48	169.50	169.80	0.30*	0.12	3.95	0.16	169.96	0.000	7.000	169.60	169.95	0.35**	0.15	3.24	0.16	170.12	0.000	0.000	n/a	1.00	0.16
14	8	0.87	169.00	169.33	0.33*	0.17	5.00	0.19	169.53	0.000	39.000	169.70	170.14	0.44**	0.24	3.54	0.19	170.34	0.000	0.000	n/a	1.20	0.23
15	8	0.67	169.70	170.14	0.44	0.21	2.75	0.16	170.30	0.000	22.000	170.20	170.59 j	0.39**	0.21	3.21	0.16	170.75	0.000	0.000	n/a	1.00	0.16
16	8	2.06	168.80	169.14	0.34*	0.18	11.37	0.57	169.71	0.000	49.000	173.20	173.83	0.63**	0.34	6.03	0.57	174.40	0.000	0.000	n/a	1.00	n/a

Project File: System 110.stm

Number of lines: 16

Run Date: 2/16/2021

Notes: * depth assumed; ** Critical depth.; j-Line contains hyd. jump ; c = cir e = ellip b = box

Hydraflow Storm Sewers Extension for Autodesk® AutoCAD® Civil 3D® Plan

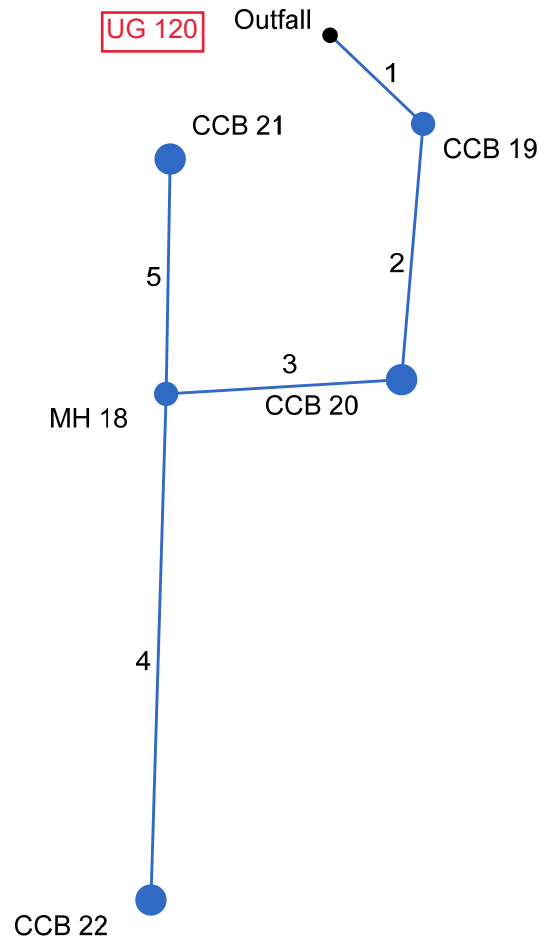

25-Year

Storm Sewer Inventory Report

Line No.	Alignment				Flow Data				Physical Data								Line ID
	Dnstr Line No.	Line Length (ft)	Defl angle (deg)	Junc Type	Known Q (cfs)	Drng Area (ac)	Runoff Coeff (C)	Inlet Time (min)	Invert El Dn (ft)	Line Slope (%)	Invert El Up (ft)	Line Size (in)	Line Shape	N Value (n)	J-Loss Coeff (K)	Inlet/ Rim El (ft)	
1	End	18.000	43.779	Comb	0.00	0.12	0.88	5.0	173.30	3.89	174.00	12	Cir	0.012	1.22	177.80	MH 17 - CCB 19
2	1	36.000	50.989	Comb	0.00	0.80	0.44	12.5	174.00	1.67	174.60	12	Cir	0.012	1.49	177.80	CCB 19 - CCB 20
3	2	33.000	81.733	MH	0.00	0.00	0.00	0.0	174.60	4.24	176.00	12	Cir	0.012	1.00	179.20	CCB 20 - MH 18
4	3	71.000	-84.789	Comb	0.00	0.28	0.43	5.0	176.00	5.63	180.00	12	Cir	0.012	1.00	183.00	MH 18 - CCB 22
5	3	33.000	94.432	Comb	0.00	0.11	0.84	5.0	176.00	1.21	176.40	12	Cir	0.012	1.00	179.60	MH 18 - CCB 21
Project File: System 120.stm												Number of lines: 5				Date: 2/16/2021	

Storm Sewer Tabulation

Station		Len (ft)	Drng Area		Rnoff coeff (C)	Area x C		Tc		Rain (l) (in/hr)	Total flow (cfs)	Cap full (cfs)	Vel (ft/s)	Pipe		Invert Elev		HGL Elev		Grnd / Rim Elev		Line ID
Line	To Line		Incr (ac)	Total (ac)		Incr	Total	Inlet (min)	Syst (min)					Size (in)	Slope (%)	Dn (ft)	Up (ft)	Dn (ft)	Up (ft)	Dn (ft)	Up (ft)	
1	End	18.000	0.12	1.31	0.88	0.11	0.67	5.0	12.6	5.8	3.91	7.61	5.27	12	3.89	173.30	174.00	174.48	174.84	178.20	177.80	MH 17 - CCB 19
2	1	36.000	0.80	1.19	0.44	0.35	0.56	12.5	12.5	5.9	3.31	4.98	4.88	12	1.67	174.00	174.60	174.84	175.38	177.80	177.80	CCB 19 - CCB 20
3	2	33.000	0.00	0.39	0.00	0.00	0.21	0.0	5.4	8.8	1.88	7.95	3.40	12	4.24	174.60	176.00	175.38	176.58	177.80	179.20	CCB 20 - MH 18
4	3	71.000	0.28	0.28	0.43	0.12	0.12	5.0	5.0	9.1	1.10	9.16	2.80	12	5.63	176.00	180.00	176.58	180.44	179.20	183.00	MH 18 - CCB 22
5	3	33.000	0.11	0.11	0.84	0.09	0.09	5.0	5.0	9.1	0.84	4.25	2.40	12	1.21	176.00	176.40	176.58	176.78	179.20	179.60	MH 18 - CCB 21

Project File: System 120.stm

Number of lines: 5

Run Date: 2/16/2021

NOTES: Intensity = $40.58 / (\text{Inlet time} + 3.50)^{0.70}$; Return period = Yrs. 25 ; c = cir e = ellip b = box

Hydraulic Grade Line Computations

Line	Size (in)	Q (cfs)	Downstream								Len (ft)	Upstream								Check		JL coeff (K)	Minor loss (ft)
			Invert elev (ft)	HGL elev (ft)	Depth (ft)	Area (sqft)	Vel (ft/s)	Vel head (ft)	EGL elev (ft)	Sf (%)		Invert elev (ft)	HGL elev (ft)	Depth (ft)	Area (sqft)	Vel (ft/s)	Vel head (ft)	EGL elev (ft)	Sf (%)	Ave Sf (%)	Enrgy loss (ft)		
1	12	3.91	173.30	174.48	1.00	0.70	4.98	0.39	174.87	1.027	18.000	174.00	174.84 j	0.84**	0.70	5.56	0.48	175.32	0.987	1.007	n/a	1.22	0.59
2	12	3.31	174.00	174.84	0.84	0.66	4.71	0.40	175.23	0.000	36.000	174.60	175.38 j	0.78**	0.66	5.05	0.40	175.77	0.000	0.000	n/a	1.49	0.59
3	12	1.88	174.60	175.38	0.78	0.48	2.86	0.24	175.62	0.000	33.000	176.00	176.58 j	0.58**	0.48	3.95	0.24	176.82	0.000	0.000	n/a	1.00	n/a
4	12	1.10	176.00	176.58	0.58	0.33	2.31	0.17	176.75	0.000	71.000	180.00	180.44 j	0.44**	0.33	3.29	0.17	180.61	0.000	0.000	n/a	1.00	0.17
5	12	0.84	176.00	176.58	0.58	0.28	1.77	0.14	176.73	0.000	33.000	176.40	176.78 j	0.38**	0.28	3.04	0.14	176.93	0.000	0.000	n/a	1.00	0.14

Project File: System 120.stm

Number of lines: 5

Run Date: 2/16/2021

Notes: ; ** Critical depth.; j-Line contains hyd. jump ; c = cir e = ellip b = box

Hydraflow Storm Sewers Extension for Autodesk® AutoCAD® Civil 3D® Plan

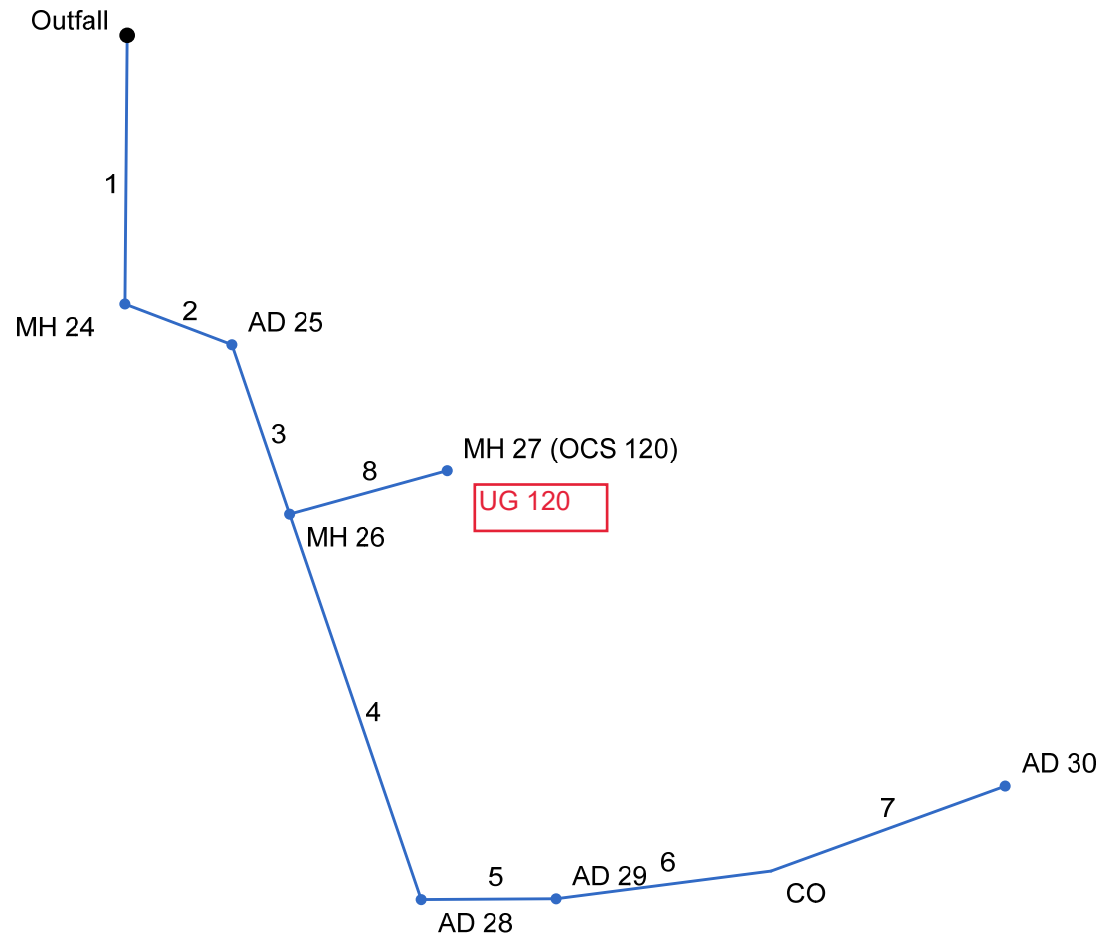

25-Year

UG 120

Storm Sewer Inventory Report

Line No.	Alignment				Flow Data				Physical Data							Line ID	
	Dnstr Line No.	Line Length (ft)	Defl angle (deg)	Junc Type	Known Q (cfs)	Drng Area (ac)	Runoff Coeff (C)	Inlet Time (min)	Invert El Dn (ft)	Line Slope (%)	Invert El Up (ft)	Line Size (in)	Line Shape	N Value (n)	J-Loss Coeff (K)		Inlet/ Rim El (ft)
1	End	66.000	90.466	MH	0.00	0.00	0.00	0.0	150.00	2.42	151.60	15	Cir	0.012	0.95	156.00	FES 23 - MH 24
2	1	28.000	-69.529	DrGrt	0.00	0.14	0.26	5.0	152.50	8.93	155.00	12	Cir	0.012	1.21	164.00	MH 24 - AD 25
3	2	44.000	50.306	MH	0.00	0.00	0.00	0.0	161.00	9.77	165.30	12	Cir	0.012	1.00	172.00	AD 25 - MH 26
4	3	100.000	0.000	DrGrt	0.00	0.07	0.25	5.0	165.30	9.70	175.00	12	Cir	0.012	1.44	184.30	MH 26 - AD 28
5	4	33.000	-71.667	DrGrt	0.00	0.74	0.29	10.0	180.50	2.12	181.20	12	Cir	0.012	0.50	185.60	AD 28 - AD 29
6	5	53.000	-6.895	None	0.00	0.00	0.00	0.0	181.20	1.13	181.80	12	Cir	0.012	0.26	183.70	AD 29 - CO
7	6	61.000	-12.714	DrGrt	0.00	0.75	0.33	12.5	181.80	1.15	182.50	12	Cir	0.012	1.00	185.60	CO - AD 30
8	3	40.000	-86.784	MH	1.64	0.00	0.00	0.0	167.00	10.00	171.00	12	Cir	0.012	1.00	179.50	MH 26 - MH 27

Project File: Outlet 120 System 100.stm

Number of lines: 8

Date: 2/16/2021

Storm Sewer Tabulation

Station		Len (ft)	Drng Area		Rnoff coeff (C)	Area x C		Tc		Rain (l) (in/hr)	Total flow (cfs)	Cap full (cfs)	Vel (ft/s)	Pipe		Invert Elev		HGL Elev		Grnd / Rim Elev		Line ID
Line	To Line		Incr (ac)	Total (ac)		Incr	Total	Inlet (min)	Syst (min)					Size (in)	Slope (%)	Dn (ft)	Up (ft)	Dn (ft)	Up (ft)	Dn (ft)	Up (ft)	
1	End	66.000	0.00	1.70	0.00	0.00	0.52	0.0	13.7	5.6	4.52	10.89	4.35	15	2.42	150.00	151.60	151.25	152.46	151.36	156.00	FES 23 - MH 24
2	1	28.000	0.14	1.70	0.26	0.04	0.52	5.0	13.6	5.6	4.52	11.53	9.96	12	8.93	152.50	155.00	152.94	155.89	156.00	164.00	MH 24 - AD 25
3	2	44.000	0.00	1.56	0.00	0.00	0.48	0.0	13.6	5.6	4.33	12.06	10.01	12	9.77	161.00	165.30	161.41	166.17	164.00	172.00	AD 25 - MH 26
4	3	100.000	0.07	1.56	0.25	0.02	0.48	5.0	13.2	5.7	2.73	12.02	4.17	12	9.70	165.30	175.00	166.17	175.71	172.00	184.30	MH 26 - AD 28
5	4	33.000	0.74	1.49	0.29	0.21	0.46	10.0	13.1	5.7	2.64	5.62	5.79	12	2.12	180.50	181.20	180.98	181.90	184.30	185.60	AD 28 - AD 29
6	5	53.000	0.00	0.75	0.00	0.00	0.25	0.0	12.8	5.8	1.43	4.10	3.02	12	1.13	181.20	181.80	181.90	182.31	185.60	183.70	AD 29 - CO
7	6	61.000	0.75	0.75	0.33	0.25	0.25	12.5	12.5	5.9	1.45	4.13	3.62	12	1.15	181.80	182.50	182.31	183.01	183.70	185.60	CO - AD 30
8	3	40.000	0.00	0.00	0.00	0.00	0.00	0.0	0.0	0.0	1.64	12.20	7.29	12	10.00	167.00	171.00	167.25	171.54	172.00	179.50	MH 26 - MH 27

Project File: Outlet 120 System 100.stm

Number of lines: 8

Run Date: 2/16/2021

NOTES: Intensity = 40.58 / (Inlet time + 3.50) ^ 0.70; Return period = Yrs. 25 ; c = cir e = ellip b = box

Hydraulic Grade Line Computations

Line	Size (in)	Q (cfs)	Downstream								Len (ft)	Upstream								Check		JL coeff (K)	Minor loss (ft)
			Invert elev (ft)	HGL elev (ft)	Depth (ft)	Area (sqft)	Vel (ft/s)	Vel head (ft)	EGL elev (ft)	Sf (%)		Invert elev (ft)	HGL elev (ft)	Depth (ft)	Area (sqft)	Vel (ft/s)	Vel head (ft)	EGL elev (ft)	Sf (%)	Ave Sf (%)	Enrgy loss (ft)		
1	15	4.52	150.00	151.25	1.25	0.90	3.68	0.21	151.46	0.417	66.000	151.60	152.46 j	0.86**	0.90	5.01	0.39	152.85	0.621	0.519	n/a	0.95	0.37
2	12	4.52	152.50	152.94	0.44*	0.33	13.78	0.59	153.52	0.000	28.000	155.00	155.89	0.89**	0.74	6.14	0.59	156.47	0.000	0.000	n/a	1.21	0.71
3	12	4.33	161.00	161.41	0.41*	0.31	14.08	0.55	161.96	0.000	44.000	165.30	166.17	0.87**	0.73	5.95	0.55	166.72	0.000	0.000	n/a	1.00	n/a
4	12	2.73	165.30	166.17	0.87	0.59	3.75	0.33	166.50	0.000	100.000	175.00	175.71 j	0.71**	0.59	4.60	0.33	176.04	0.000	0.000	n/a	1.44	0.47
5	12	2.64	180.50	180.98	0.48*	0.38	7.04	0.32	181.30	0.000	33.000	181.20	181.90	0.70**	0.58	4.53	0.32	182.21	0.000	0.000	n/a	0.50	0.16
6	12	1.43	181.20	181.90	0.70	0.40	2.46	0.20	182.10	0.000	53.000	181.80	182.31 j	0.51**	0.40	3.59	0.20	182.51	0.000	0.000	n/a	0.26	0.05
7	12	1.45	181.80	182.31	0.51	0.40	3.63	0.20	182.51	0.000	61.000	182.50	183.01	0.51**	0.40	3.60	0.20	183.21	0.000	0.000	n/a	1.00	0.20
8	12	1.64	167.00	167.25	0.25*	0.15	10.82	0.22	167.47	0.000	40.000	171.00	171.54	0.54**	0.44	3.76	0.22	171.76	0.000	0.000	n/a	1.00	0.22

Project File: Outlet 120 System 100.stm

Number of lines: 8

Run Date: 2/16/2021

Notes: * depth assumed; ** Critical depth.; j-Line contains hyd. jump ; c = cir e = ellip b = box

Hydraflow Storm Sewers Extension for Autodesk® AutoCAD® Civil 3D® Plan

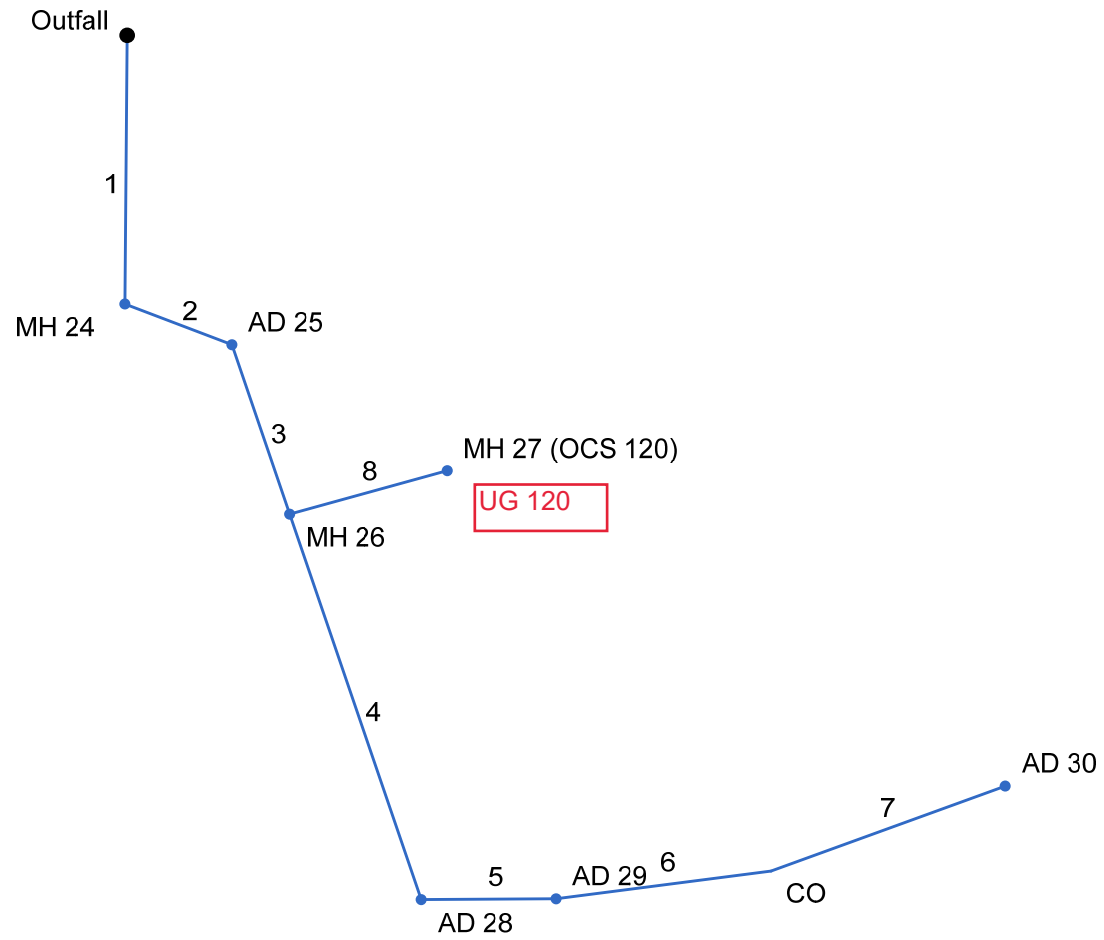

100-Year

UG 120

Storm Sewer Inventory Report

Line No.	Alignment				Flow Data				Physical Data							Line ID	
	Dnstr Line No.	Line Length (ft)	Defl angle (deg)	Junc Type	Known Q (cfs)	Drng Area (ac)	Runoff Coeff (C)	Inlet Time (min)	Invert El Dn (ft)	Line Slope (%)	Invert El Up (ft)	Line Size (in)	Line Shape	N Value (n)	J-Loss Coeff (K)		Inlet/ Rim El (ft)
1	End	66.000	90.466	MH	0.00	0.00	0.00	0.0	150.00	2.42	151.60	15	Cir	0.012	0.95	156.00	FES 23 - MH 24
2	1	28.000	-69.529	DrGrt	0.00	0.14	0.26	5.0	152.50	8.93	155.00	12	Cir	0.012	1.21	164.00	MH 24 - AD 25
3	2	44.000	50.306	MH	0.00	0.00	0.00	0.0	161.00	9.77	165.30	12	Cir	0.012	1.00	172.00	AD 25 - MH 26
4	3	100.000	0.000	DrGrt	0.00	0.07	0.25	5.0	165.30	9.70	175.00	12	Cir	0.012	1.44	184.30	MH 26 - AD 28
5	4	33.000	-71.667	DrGrt	0.00	0.74	0.29	10.0	180.50	2.12	181.20	12	Cir	0.012	0.50	185.60	AD 28 - AD 29
6	5	53.000	-6.895	None	0.00	0.00	0.00	0.0	181.20	1.13	181.80	12	Cir	0.012	0.26	183.70	AD 29 - CO
7	6	61.000	-12.714	DrGrt	0.00	0.75	0.33	12.5	181.80	1.15	182.50	12	Cir	0.012	1.00	185.60	CO - AD 30
8	3	40.000	-86.784	MH	3.97	0.00	0.00	0.0	167.00	10.00	171.00	12	Cir	0.012	1.00	179.50	MH 26 - MH 27

Project File: Outlet 120 System 100.stm

Number of lines: 8

Date: 2/16/2021

Storm Sewer Tabulation

Station		Len (ft)	Drng Area		Rnoff coeff (C)	Area x C		Tc		Rain (l) (in/hr)	Total flow (cfs)	Cap full (cfs)	Vel (ft/s)	Pipe		Invert Elev		HGL Elev		Grnd / Rim Elev		Line ID
Line	To Line		Incr (ac)	Total (ac)		Incr	Total	Inlet (min)	Syst (min)					Size (in)	Slope (%)	Dn (ft)	Up (ft)	Dn (ft)	Up (ft)	Dn (ft)	Up (ft)	
1	End	66.000	0.00	1.70	0.00	0.00	0.52	0.0	13.6	7.1	7.65	10.89	6.47	15	2.42	150.00	151.60	151.25	152.70	151.36	156.00	FES 23 - MH 24
2	1	28.000	0.14	1.70	0.26	0.04	0.52	5.0	13.5	7.1	7.66	11.53	12.74	12	8.93	152.50	155.00	153.10	155.98	156.00	164.00	MH 24 - AD 25
3	2	44.000	0.00	1.56	0.00	0.00	0.48	0.0	13.5	7.2	7.41	12.06	12.80	12	9.77	161.00	165.30	161.57	166.28	164.00	172.00	AD 25 - MH 26
4	3	100.000	0.07	1.56	0.25	0.02	0.48	5.0	13.1	7.3	3.49	12.02	4.83	12	9.70	165.30	175.00	166.28	175.80	172.00	184.30	MH 26 - AD 28
5	4	33.000	0.74	1.49	0.29	0.21	0.46	10.0	13.0	7.3	3.37	5.62	6.29	12	2.12	180.50	181.20	181.06	181.98	184.30	185.60	AD 28 - AD 29
6	5	53.000	0.00	0.75	0.00	0.00	0.25	0.0	12.8	7.4	1.83	4.10	3.33	12	1.13	181.20	181.80	181.98	182.37	185.60	183.70	AD 29 - CO
7	6	61.000	0.75	0.75	0.33	0.25	0.25	12.5	12.5	7.5	1.85	4.13	3.94	12	1.15	181.80	182.50	182.37	183.08	183.70	185.60	CO - AD 30
8	3	40.000	0.00	0.00	0.00	0.00	0.00	0.0	0.0	0.0	3.97	12.20	9.74	12	10.00	167.00	171.00	167.39	171.84	172.00	179.50	MH 26 - MH 27

Project File: Outlet 120 System 100.stm

Number of lines: 8

Run Date: 2/16/2021

NOTES: Intensity = 53.20 / (Inlet time + 3.70) ^ 0.71; Return period = Yrs. 100 ; c = cir e = ellip b = box

Hydraulic Grade Line Computations

Line	Size (in)	Q (cfs)	Downstream								Len (ft)	Upstream								Check		JL coeff (K)	Minor loss (ft)
			Invert elev (ft)	HGL elev (ft)	Depth (ft)	Area (sqft)	Vel (ft/s)	Vel head (ft)	EGL elev (ft)	Sf (%)		Invert elev (ft)	HGL elev (ft)	Depth (ft)	Area (sqft)	Vel (ft/s)	Vel head (ft)	EGL elev (ft)	Sf (%)	Ave Sf (%)	Enrgy loss (ft)		
1	15	7.65	150.00	151.25	1.25	1.14	6.24	0.60	151.85	1.197	66.000	151.60	152.70 j	1.10**	1.14	6.71	0.70	153.40	1.080	1.139	n/a	0.95	0.66
2	12	7.66	152.50	153.10	0.60*	0.49	15.70	1.49	154.59	0.000	28.000	155.00	155.98	0.98**	0.78	9.79	1.49	157.47	0.000	0.000	n/a	1.21	n/a
3	12	7.41	161.00	161.57	0.57*	0.46	16.13	1.40	162.96	0.000	44.000	165.30	166.28	0.98**	0.78	9.48	1.40	167.68	0.000	0.000	n/a	1.00	1.40
4	12	3.49	165.30	166.28	0.98	0.67	4.46	0.42	166.70	0.000	100.000	175.00	175.80 j	0.80**	0.67	5.19	0.42	176.22	0.000	0.000	n/a	1.44	n/a
5	12	3.37	180.50	181.06	0.56*	0.45	7.47	0.40	181.46	0.000	33.000	181.20	181.98	0.78**	0.66	5.10	0.40	182.39	0.000	0.000	n/a	0.50	0.20
6	12	1.83	181.20	181.98	0.78	0.47	2.76	0.24	182.22	0.000	53.000	181.80	182.37 j	0.57**	0.47	3.91	0.24	182.61	0.000	0.000	n/a	0.26	n/a
7	12	1.85	181.80	182.37	0.57	0.47	3.95	0.24	182.61	0.000	61.000	182.50	183.08	0.58**	0.47	3.92	0.24	183.32	0.000	0.000	n/a	1.00	0.24
8	12	3.97	167.00	167.39	0.39*	0.29	13.87	0.49	167.88	0.000	40.000	171.00	171.84	0.84**	0.71	5.61	0.49	172.33	0.000	0.000	n/a	1.00	0.49

Project File: Outlet 120 System 100.stm

Number of lines: 8

Run Date: 2/16/2021

Notes: * depth assumed; ** Critical depth.; j-Line contains hyd. jump ; c = cir e = ellip b = box

Hydraflow Storm Sewers Extension for Autodesk® AutoCAD® Civil 3D® Plan

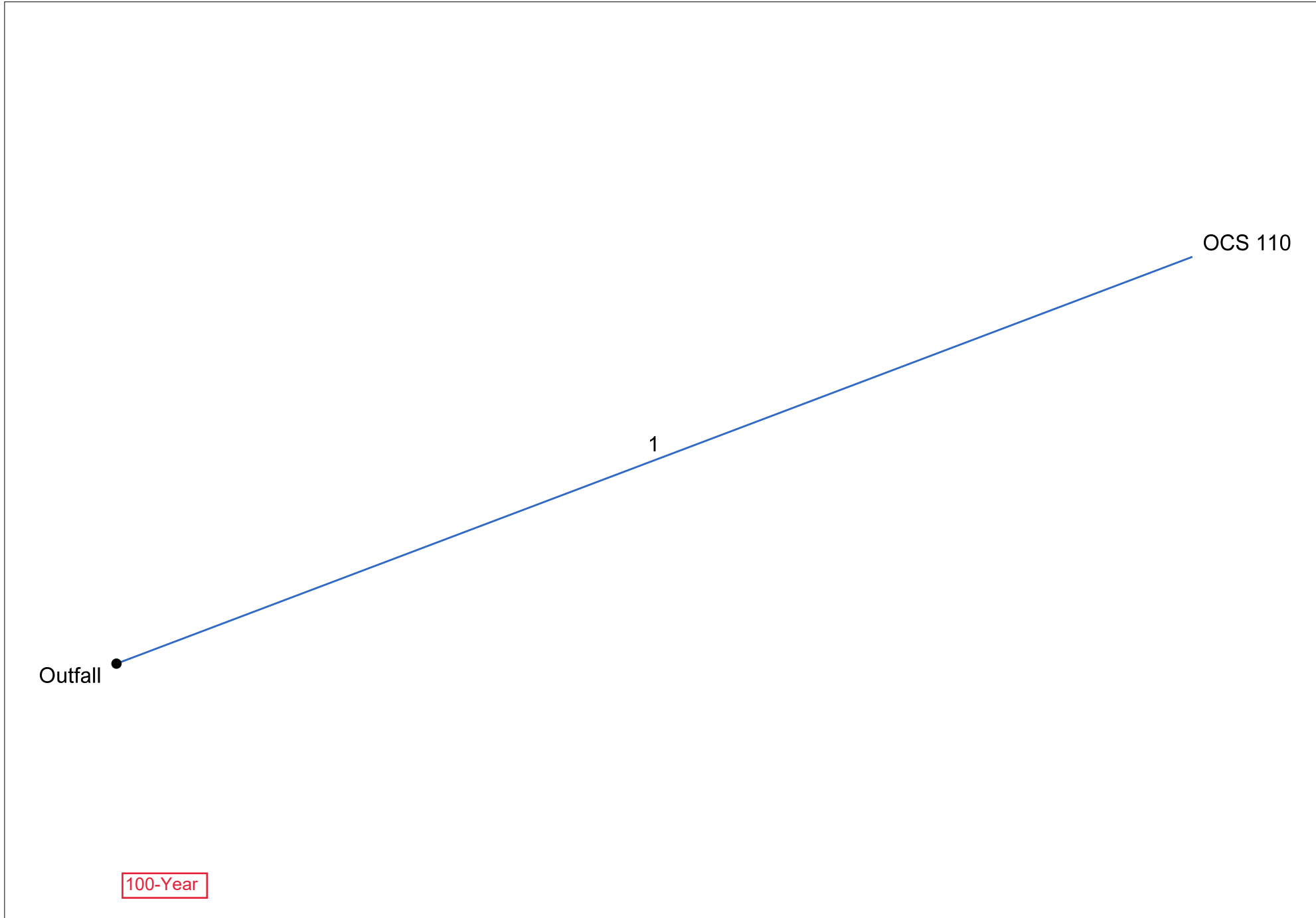

Project File: Outlet 110.stm

Number of lines: 1

Date: 2/16/2021

Storm Sewer Inventory Report

Line No.	Alignment				Flow Data				Physical Data							Line ID	
	Dnstr Line No.	Line Length (ft)	Defl angle (deg)	Junc Type	Known Q (cfs)	Drng Area (ac)	Runoff Coeff (C)	Inlet Time (min)	Invert El Dn (ft)	Line Slope (%)	Invert El Up (ft)	Line Size (in)	Line Shape	N Value (n)	J-Loss Coeff (K)		Inlet/ Rim El (ft)
1	End	115.000	-20.871	None	10.11	0.00	0.00	0.0	150.50	2.17	153.00	18	Cir	0.012	1.00	158.20	FES 1 - OCS 110

Project File: Outlet 110.stm

Number of lines: 1

Date: 2/16/2021

Storm Sewer Tabulation

Station		Len (ft)	Drng Area		Rnoff coeff (C)	Area x C		Tc		Rain (l) (in/hr)	Total flow (cfs)	Cap full (cfs)	Vel (ft/s)	Pipe		Invert Elev		HGL Elev		Grnd / Rim Elev		Line ID
Line	To Line		Incr (ac)	Total (ac)		Incr	Total	Inlet (min)	Syst (min)					Size (in)	Slope (%)	Dn (ft)	Up (ft)	Dn (ft)	Up (ft)	Dn (ft)	Up (ft)	
1	End	115.000	0.00	0.00	0.00	0.00	0.00	0.0	0.0	0.0	10.11	16.77	6.49	18	2.17	150.50	153.00	151.75	154.22	152.00	158.20	FES 1 - OCS 110

Project File: Outlet 110.stm

Number of lines: 1

Run Date: 2/16/2021

NOTES: Intensity = $127.16 / (\text{Inlet time} + 17.80)^{0.82}$; Return period = Yrs. 100 ; c = cir e = ellip b = box

Hydraulic Grade Line Computations

Line	Size (in)	Q (cfs)	Downstream								Len (ft)	Upstream								Check		JL coeff (K)	Minor loss (ft)
			Invert elev (ft)	HGL elev (ft)	Depth (ft)	Area (sqft)	Vel (ft/s)	Vel head (ft)	EGL elev (ft)	Sf (%)		Invert elev (ft)	HGL elev (ft)	Depth (ft)	Area (sqft)	Vel (ft/s)	Vel head (ft)	EGL elev (ft)	Sf (%)	Ave Sf (%)	Enrgy loss (ft)		
1	18	10.11	150.50	151.75	1.25	1.54	6.42	0.67	152.42	0.000	115.000	153.00	154.22 j	1.22**	1.54	6.55	0.67	154.89	0.000	0.000	n/a	1.00	n/a

Project File: Outlet 110.stm

Number of lines: 1

Run Date: 2/16/2021

Notes: ; ** Critical depth.; j-Line contains hyd. jump ; c = cir e = ellip b = box

Outlet Protection Calculations

Project: Slate Upper School By: AWG Date: 10/24/20
Location: 5100 Ridge Road, North Haven, CT Rev.: MCB Date: 02/16/21
Outlet I.D.: **FES 3**

*Based on Connecticut DOT Drainage Manual, Section 11.13

Description:

FES 3

Design Criteria (25-yr Storm Event):

Q (cfs) = 6.25 R_p (ft) = 1.25
 D (in) = 15 S_p (ft) = 1.25
 V (fps) = 5.49 T_w (ft) = 0.72

Q = Flow rate at discharge point in cubic feet per second (cfs)
 D = Outlet pipe diameter (in)
 V = Flow velocity at discharge point (ft/s)
 R_p = Maximum inside pipe rise (ft)
 S_p = inside diameters for circular sections of maximum inside pipe span for non-circular sections (ft)
 T_w = Tailwater depth (ft)

Based on **Table 11-13.1** use Type 'B' ---> $TW \geq 0.5 R_p$

Rip Rap Stone Size:

<u>Velocity</u>	<u>Rip Rap Specification</u>	<u>D₅₀ Stone Size</u>
0-8 fps	Modified	5 inches

Preformed Scour Hole Dimensions:

F (ft)= $0.5(R_p)$ = n/a
 C (ft)= $3.0(S_p)+6.0(F)$ = n/a
 B (ft)= $2.0(S_p)+6.0(F)$ = n/a

Rip Rap Splash Pad Dimensions:

L_a = 12 ft
 $W1 = 3.0(S_p)$ min. = 4 ft
 $W2 = 3.0(S_p)+0.4(L_a)$ min. = 9 ft
 d (Depth of Stone) = 12 inches

Level Spreader Design

Level Spreader 110

Broad Crest Elevation (ft)	151.00
Length (ft)	45
Discharge Coefficient	3.2
Elevation Increment	0.05
Q-100 year (cfs)	10.11

Elevation (Feet)	Weir Discharge (cfs)	Area (sf)	Velocity (fps)
151.00	0.00	0.00	0.00
151.05	1.61	2.25	0.72
151.10	4.55	4.50	1.01
151.15	8.37	6.75	1.24
151.17	10.11	7.66	1.32
151.20	12.88	9.00	1.43
151.25	18.00	11.25	1.60
151.30	23.66	13.50	1.75
151.35	29.82	15.75	1.89
151.40	36.43	18.00	2.02
151.45	43.47	20.25	2.15
151.50	50.91	22.50	2.26



LEGEND

— DRAINAGE AREA BOUNDARY

CCB # DRAINAGE AREA LABEL

- - - TIME OF CONCENTRATION PATH

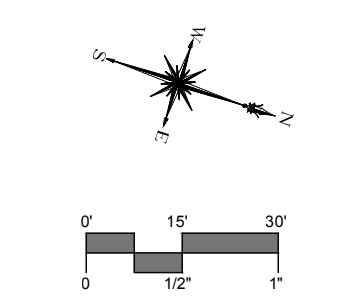

MILONE & MACBROOM
 99 BEAULTY DRIVE
 CHESHIRE, CT 06610
 WWW.MAMING.COM

DESCRIPTION	DATE	BY
TOWN COMMENTS	12/10/20	MCB
PLAN REVISIONS	02/16/21	MCB

DRAINAGE AREA MAP - STORM DRAINAGE SYSTEM

SLATE UPPER SCHOOL

5100 RIDGE ROAD
 NORTH HAVEN, CONNECTICUT

AWG DESIGNED	AWG DRAWN	FAB CHECKED

SCALE: 1"=30'

DATE: OCTOBER 27, 2020

PROJECT NO.: 6156-03

CB

SHEET NAME

Copyright Milone & MacBroom, Inc. - 2020

ATTACHMENT E

WATER QUALITY COMPUTATIONS

STORMWATER QUALITY CALCULATIONS
Water Quality Volume (WQV)

WS ID	Total Area (ac.)	Impervious Area (ac.)	Percent Impervious	Volumetric Runoff Coeff., R	WQV (ac-ft)	Total Volume Required (ac-ft)	Total Volume Provided ^{1.} (ac-ft)
11	1.28	0.45	35.2%	0.37	0.039	0.039	
12	1.32	0.56	42.4%	0.43	0.048	0.048	
TOTAL 11 + 12 =						0.087	0.097

1.- Volume provided below the low-flow orifice in the outlet control structure of Aboveground DET 110

$$WQV = \frac{(1.0 \text{ inches}) \times A \times R}{12}$$

Where:

- WQV = Water Quality Volume in acre-feet
- A = Contributing Area in acres
- R = 0.05 + 0.009 (I)
- I = Site Imperviousness as percent

STORMWATER QUALITY CALCULATIONS
Retention Volume Provided

Stormwater Basin 110:

Elevation	Surface Area	Volume	Volume (ac-ft)	Cumulative Volume (ac-ft)
153.0	600	0.0	0.000	0.000
154.0	1,025	813	0.019	0.019
155.0	1,475	1,250	0.029	0.047
156.0	2,000	1,738	0.040	0.087
156.2	2,250	425	0.010	0.097

		MILONE AND MACBROOM, INC.			Project	6156-03
		COMPUTATION SHEET - WATER QUALITY FLOW (WQF)			Made By:	FAB
Subject:	Slate Upper School - North Haven, CT				Date:	Rev 2/16/2021
					Chkd by:	
					Date:	
CDS Unit (WS 11 + WS 12 Impervious Area)						
Contributing Basins			Imperv. Area (acres)	Total Area (acres)		
Total			1.01	1.01		
Table 4.1: $WQV = (P)(R_v)(A)/12 =$				0.080	acre-feet	
Where:						
I = % of Impervious Cover =				100%		
$R_v =$ volumetric runoff coeff. $0.05 + 0.009(I) =$				0.950		
P = design precipitation (1.0" for water quality storm) =				1	inch	
A = site area (acres) =			1.01	acres =	0.0016	miles ²
Q = runoff depth (in watershed inches) = $[WQV(\text{acrefeet})][12(\text{inches/foot})]/\text{drainage area (acres)}$						
			Q =	0.950		
CN = $1000 / [10 + 5P + 10Q - 10(Q^2 + 1.25QP)^{0.5}] =$				98		
Where:						
Q = runoff depth (in watershed inches)						
			$t_c =$	0.1	hours	
Type III Rainfall Distribution:						
From Table 4-1, $l_a =$		0.041	$l_a/P =$		0.041	
(TR-55)						
From Exhibit 4-III, $q_u =$		700	csm/in.			
(TR-55)						
WQF = $(q_u)(A)(Q) =$		1.05	cfs		CDS 2015-4-C Flow Capacity = 1.4 -> OK	



2. Compute the time of concentration (t_c) based on the methods described in Chapter 3 of TR-55. A minimum value of 0.167 hours (10 minutes) should be used. For sheet flow, the flow path should not be longer than 300 feet.
3. Using the computed CN, t_c , and drainage area (A) in acres, compute the peak discharge for the water quality storm (i.e., the water quality flow [WQF]), based on the procedures described in Chapter 4 of TR-55.
 - Read initial abstraction (I_a) from Table 4-1 in Chapter 4 of TR-55 (reproduced below); compute I_a/P

Table 4-1 I_a values for runoff curve numbers

Curve number	I_a (in)	Curve number	I_a (in)	Curve number	I_a (in)	Curve number	I_a (in)
40	3.000	55	1.636	70	0.857	85	0.353
41	2.878	56	1.571	71	0.817	86	0.326
42	2.762	57	1.509	72	0.778	87	0.299
43	2.651	58	1.448	73	0.740	88	0.273
44	2.545	59	1.390	74	0.703	89	0.247
45	2.444	60	1.333	75	0.667	90	0.222
46	2.348	61	1.279	76	0.632	91	0.198
47	2.255	62	1.226	77	0.597	92	0.174
48	2.167	63	1.175	78	0.564	93	0.151
49	2.082	64	1.125	79	0.532	94	0.128
50	2.000	65	1.077	80	0.500	95	0.105
51	1.922	66	1.030	81	0.469	96	0.083
52	1.846	67	0.985	82	0.439	97	0.062
53	1.774	68	0.941	83	0.410	98	0.041
54	1.704	69	0.899	84	0.381		

- Read the unit peak discharge (q_u) from Exhibit 4-III in Chapter 4 of TR-55 (reproduced below) for appropriate t_c

Exhibit 4-III Unit peak discharge (q_u) for NRCS (SCS) type III rainfall distribution

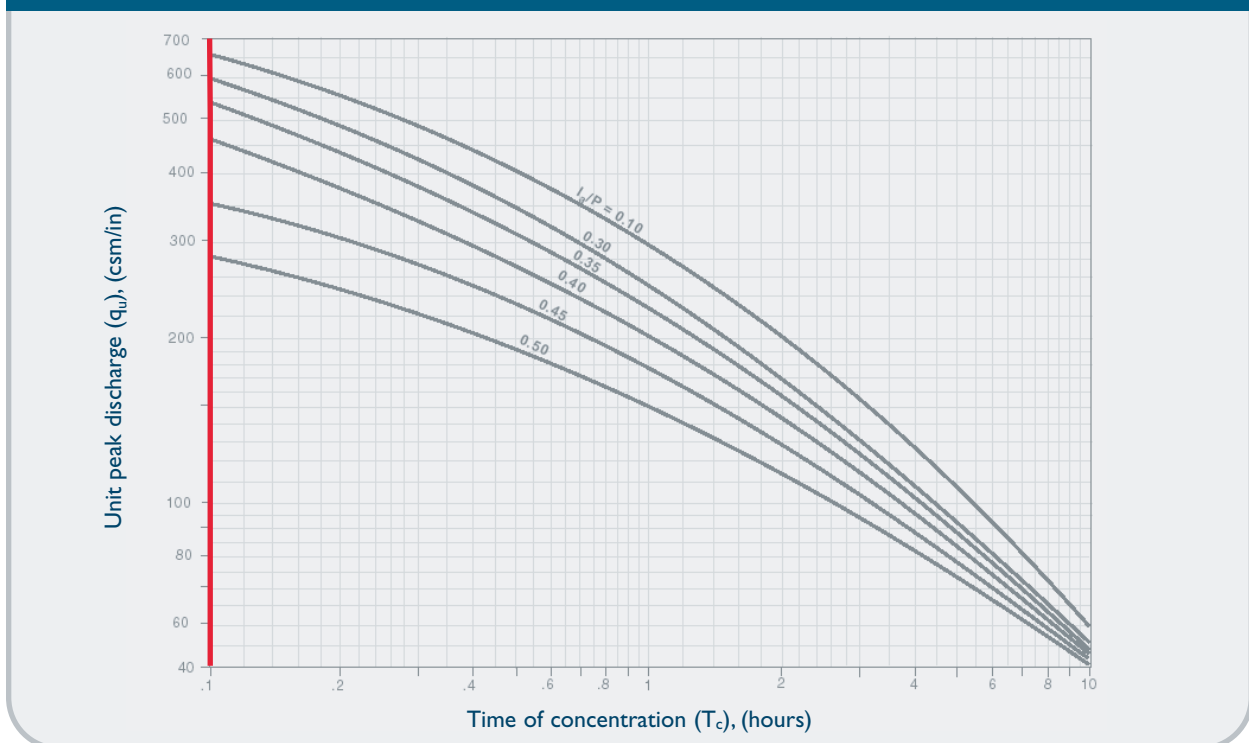

CDS2015-4-C DESIGN NOTES

THE STANDARD CDS2015-4-C CONFIGURATION IS SHOWN. ALTERNATE CONFIGURATIONS ARE AVAILABLE AND ARE LISTED BELOW. SOME CONFIGURATIONS MAY BE COMBINED TO SUIT SITE REQUIREMENTS.

CONFIGURATION DESCRIPTION

- GRATED INLET ONLY (NO INLET PIPE)
- GRATED INLET WITH INLET PIPE OR PIPES
- CURB INLET ONLY (NO INLET PIPE)
- CURB INLET WITH INLET PIPE OR PIPES
- SEPARATE OIL BAFFLE (SINGLE INLET PIPE REQUIRED FOR THIS CONFIGURATION)
- SEDIMENT WEIR FOR NJDEP / NJCAT CONFORMING UNITS

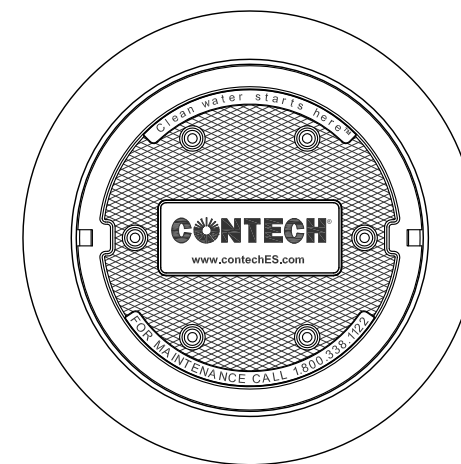
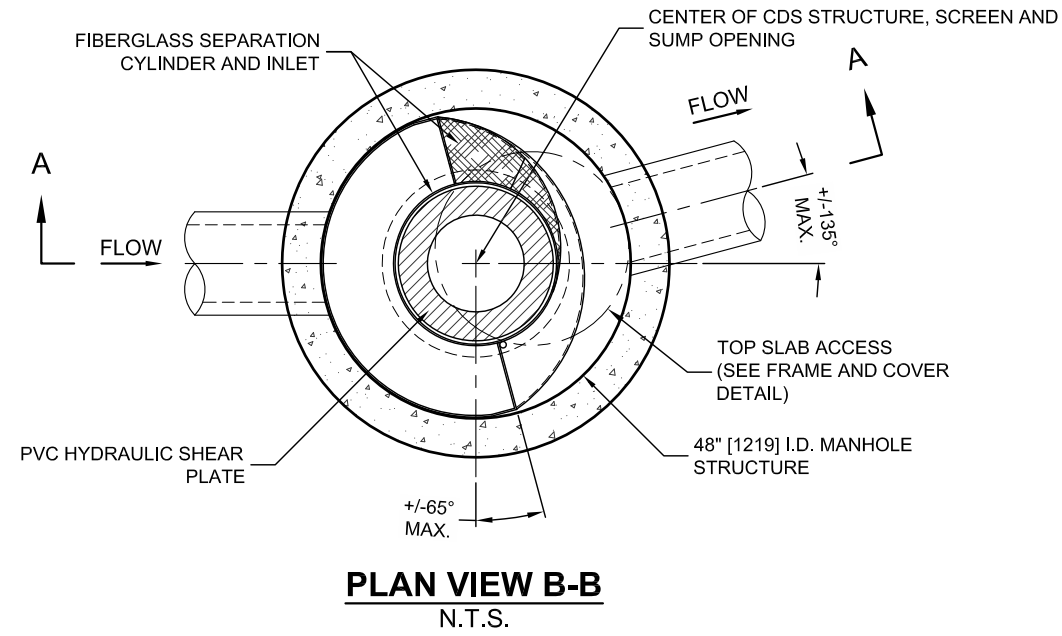

FRAME AND COVER
(DIAMETER VARIES)
N.T.S.

SITE SPECIFIC DATA REQUIREMENTS

STRUCTURE ID				
WATER QUALITY FLOW RATE (CFS OR L/s)				*
PEAK FLOW RATE (CFS OR L/s)				*
RETURN PERIOD OF PEAK FLOW (YRS)				*
SCREEN APERTURE (2400 OR 4700)				*
PIPE DATA:	I.E.	MATERIAL	DIAMETER	
INLET PIPE 1	*	*	*	
INLET PIPE 2	*	*	*	
OUTLET PIPE	*	*	*	
RIM ELEVATION				*
ANTI-FLOTATION BALLAST	*	WIDTH	*	HEIGHT
NOTES/SPECIAL REQUIREMENTS:				
* PER ENGINEER OF RECORD				

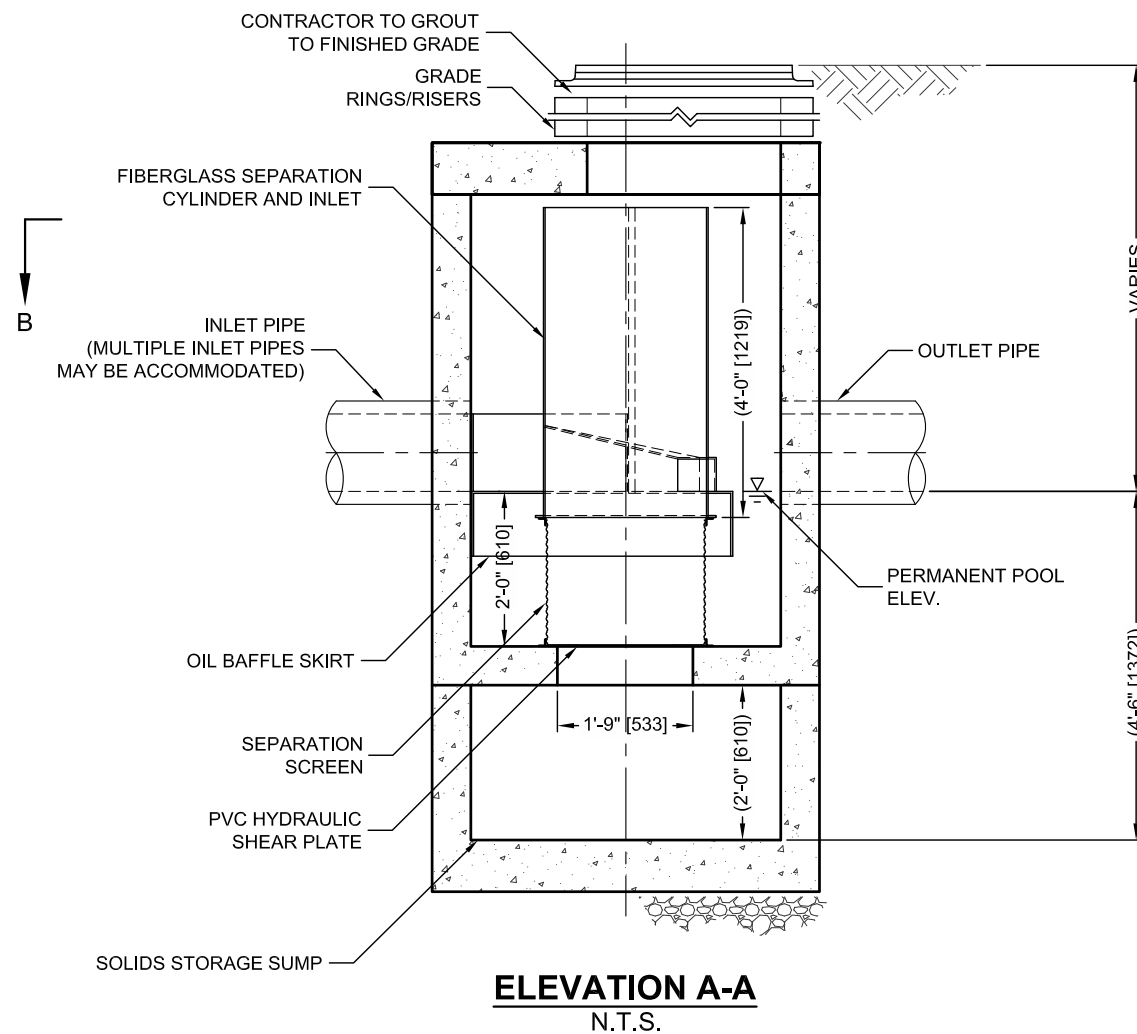

ELEVATION A-A
N.T.S.

GENERAL NOTES

1. CONTECH TO PROVIDE ALL MATERIALS UNLESS NOTED OTHERWISE.
2. DIMENSIONS MARKED WITH () ARE REFERENCE DIMENSIONS. ACTUAL DIMENSIONS MAY VARY.
3. FOR FABRICATION DRAWINGS WITH DETAILED STRUCTURE DIMENSIONS AND WEIGHTS, PLEASE CONTACT YOUR CONTECH ENGINEERED SOLUTIONS LLC REPRESENTATIVE. www.contechES.com
4. CDS WATER QUALITY STRUCTURE SHALL BE IN ACCORDANCE WITH ALL DESIGN DATA AND INFORMATION CONTAINED IN THIS DRAWING.
5. STRUCTURE SHALL MEET AASHTO HS20 AND CASTINGS SHALL MEET HS20 (AASHTO M 306) LOAD RATING, ASSUMING GROUNDWATER ELEVATION AT, OR BELOW, THE OUTLET PIPE INVERT ELEVATION. ENGINEER OF RECORD TO CONFIRM ACTUAL GROUNDWATER ELEVATION.
6. PVC HYDRAULIC SHEAR PLATE IS PLACED ON SHELF AT BOTTOM OF SCREEN CYLINDER. REMOVE AND REPLACE AS NECESSARY DURING MAINTENANCE CLEANING.

INSTALLATION NOTES

- A. ANY SUB-BASE, BACKFILL DEPTH, AND/OR ANTI-FLOTATION PROVISIONS ARE SITE-SPECIFIC DESIGN CONSIDERATIONS AND SHALL BE SPECIFIED BY ENGINEER OF RECORD.
- B. CONTRACTOR TO PROVIDE EQUIPMENT WITH SUFFICIENT LIFTING AND REACH CAPACITY TO LIFT AND SET THE CDS MANHOLE STRUCTURE (LIFTING CLUTCHES PROVIDED).
- C. CONTRACTOR TO ADD JOINT SEALANT BETWEEN ALL STRUCTURE SECTIONS, AND ASSEMBLE STRUCTURE.
- D. CONTRACTOR TO PROVIDE, INSTALL, AND GROUT PIPES. MATCH PIPE INVERTS WITH ELEVATIONS SHOWN.
- E. CONTRACTOR TO TAKE APPROPRIATE MEASURES TO ASSURE UNIT IS WATER TIGHT, HOLDING WATER TO FLOWLINE INVERT MINIMUM. IT IS SUGGESTED THAT ALL JOINTS BELOW PIPE INVERTS ARE GROUTED.

CONTECH
ENGINEERED SOLUTIONS LLC

www.contechES.com
9025 Centre Pointe Dr., Suite 400, West Chester, OH 45069
800-338-1122 513-645-7000 513-645-7993 FAX

CDS2015-4-C
INLINE CDS
STANDARD DETAIL



THIS PRODUCT MAY BE PROTECTED BY ONE OR MORE OF THE FOLLOWING U.S. PATENTS: 6,788,040; 6,841,720; 6,911,565; 6,981,762. RELATED FOREIGN PATENTS, OR OTHER PATENTS PENDING.

Product Flow Rates

CASCADE

Model	Treatment Rate (cfs)	Sediment Capacity ¹ (CF)
CS-4	2.00	19
CS-5	3.50	29
CS-6	5.60	42
CS-8	12.00	75
CS-10	18.00	118

CDS

Model	Treatment Rate ² (cfs)	Sediment Capacity ¹ (CF)
1515-3	1.00	14
2015-4	1.40	25
2015-5	1.40	39
2015-6	1.40	57
2020-5	2.20	39
2020-6	2.20	57
2025-5	3.20	39
2025-6	3.20	57
3020-6	3.90	57
3025-6	5.00	57
3030-6	5.70	57
3035-6	6.50	57
4030-8	7.50	151
4040-8	9.50	151

VORTECHS

Model	Treatment Rate (cfs)	Sediment Capacity ³ (CF)
1000	1.60	16
2000	2.80	32
3000	4.50	49
4000	6.00	65
5000	8.50	86
7000	11.00	108
9000	14.00	130
11000	17.5	151
16000	25	192

STORMCEPTOR STC

Model	Treatment Rate (cfs)	Sediment Capacity ¹ (CF)
STC 450i	0.40	46
STC 900	0.89	89
STC 2400	1.58	205
STC 4800	2.47	543
STC 7200	3.56	839
STC 11000	4.94	1086
STC 16000	7.12	1677

1 Additional sediment storage capacity available – Check with your local representative for information.

2 Treatment Capacity is based on laboratory testing using OK-110 (average D50 particle size of approximately 100 microns) and a 2400 micron screen.

3 Maintenance recommended when sediment depth has accumulated to within 12-18 inches of the dry weather water surface elevation.



NOTHING IN THIS CATALOG SHOULD BE CONSTRUED AS A WARRANTY. APPLICATIONS SUGGESTED HEREIN ARE DESCRIBED ONLY TO HELP READERS MAKE THEIR OWN EVALUATIONS AND DECISIONS, AND ARE NEITHER GUARANTEES NOR WARRANTIES OF SUITABILITY FOR ANY APPLICATION. CONTECH MAKES NO WARRANTY WHATSOEVER, EXPRESS OR IMPLIED, RELATED TO THE APPLICATIONS, MATERIALS, COATINGS, OR PRODUCTS DISCUSSED HEREIN. ALL IMPLIED WARRANTIES OF MERCHANTABILITY AND ALL IMPLIED WARRANTIES OF FITNESS FOR ANY PARTICULAR PURPOSE ARE DISCLAIMED BY CONTECH. SEE CONTECH'S CONDITIONS OF SALE (AVAILABLE AT WWW.CONTECHES.COM/COS) FOR MORE INFORMATION.



Get social with us: [f](#) [in](#) [t](#) [v](#)

800-338-1122 | www.ContechES.com

CDS Guide

Operation, Design, Performance and Maintenance



CDS®

Using patented continuous deflective separation technology, the CDS system screens, separates and traps debris, sediment, and oil and grease from stormwater runoff. The indirect screening capability of the system allows for 100% removal of floatables and neutrally buoyant material without blinding. Flow and screening controls physically separate captured solids, and minimize the re-suspension and release of previously trapped pollutants. Inline units can treat up to 6 cfs, and internally bypass flows in excess of 50 cfs (1416 L/s). Available precast or cast-in-place, offline units can treat flows from 1 to 300 cfs (28.3 to 8495 L/s). The pollutant removal capacity of the CDS system has been proven in lab and field testing.

Operation Overview

Stormwater enters the diversion chamber where the diversion weir guides the flow into the unit's separation chamber and pollutants are removed from the flow. All flows up to the system's treatment design capacity enter the separation chamber and are treated.

Swirl concentration and screen deflection force floatables and solids to the center of the separation chamber where 100% of floatables and neutrally buoyant debris larger than the screen apertures are trapped.

Stormwater then moves through the separation screen, under the oil baffle and exits the system. The separation screen remains clog free due to continuous deflection.

During the flow events exceeding the treatment design capacity, the diversion weir bypasses excessive flows around the separation chamber, so captured pollutants are retained in the separation cylinder.

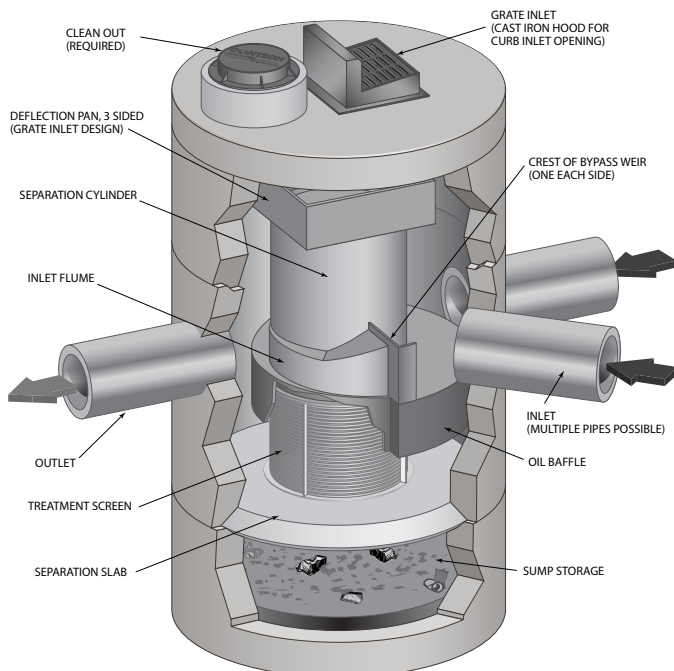

Design Basics

There are three primary methods of sizing a CDS system. The Water Quality Flow Rate Method determines which model size provides the desired removal efficiency at a given flow rate for a defined particle size. The Rational Rainfall Method™ or the Probabilistic Method is used when a specific removal efficiency of the net annual sediment load is required.

Typically in the United States, CDS systems are designed to achieve an 80% annual solids load reduction based on lab generated performance curves for a gradation with an average particle size (d50) of 125 microns (μm). For some regulatory environments, CDS systems can also be designed to achieve an 80% annual solids load reduction based on an average particle size (d50) of 75 microns (μm) or 50 microns (μm).

Water Quality Flow Rate Method

In some cases, regulations require that a specific treatment rate, often referred to as the water quality design flow (WQQ), be treated. This WQQ represents the peak flow rate from either an event with a specific recurrence interval, e.g. the six-month storm, or a water quality depth, e.g. 1/2-inch (13 mm) of rainfall.

The CDS is designed to treat all flows up to the WQQ. At influent rates higher than the WQQ, the diversion weir will direct most flow exceeding the WQQ around the separation chamber. This allows removal efficiency to remain relatively constant in the separation chamber and eliminates the risk of washout during bypass flows regardless of influent flow rates.

Treatment flow rates are defined as the rate at which the CDS will remove a specific gradation of sediment at a specific removal efficiency. Therefore the treatment flow rate is variable, based on the gradation and removal efficiency specified by the design engineer.

Rational Rainfall Method™

Differences in local climate, topography and scale make every site hydraulically unique. It is important to take these factors into consideration when estimating the long-term performance of any stormwater treatment system. The Rational Rainfall Method combines site-specific information with laboratory generated performance data, and local historical precipitation records to estimate removal efficiencies as accurately as possible.

Short duration rain gauge records from across the United States and Canada were analyzed to determine the percent of the total annual rainfall that fell at a range of intensities. US stations' depths were totaled every 15 minutes, or hourly, and recorded in 0.01-inch increments. Depths were recorded hourly with 1-mm resolution at Canadian stations. One trend was consistent at all sites; the vast majority of precipitation fell at low intensities and high intensity storms contributed relatively little to the total annual depth.

These intensities, along with the total drainage area and runoff coefficient for each specific site, are translated into flow rates using the Rational Rainfall Method. Since most sites are relatively small and highly impervious, the Rational Rainfall Method is appropriate. Based on the runoff flow rates calculated for each intensity, operating rates within a proposed CDS system are

determined. Performance efficiency curve determined from full scale laboratory tests on defined sediment PSDs is applied to calculate solids removal efficiency. The relative removal efficiency at each operating rate is added to produce a net annual pollutant removal efficiency estimate.

Probabilistic Rational Method

The Probabilistic Rational Method is a sizing program Contech developed to estimate a net annual sediment load reduction for a particular CDS model based on site size, site runoff coefficient, regional rainfall intensity distribution, and anticipated pollutant characteristics.

The Probabilistic Method is an extension of the Rational Method used to estimate peak discharge rates generated by storm events of varying statistical return frequencies (e.g. 2-year storm event). Under the Rational Method, an adjustment factor is used to adjust the runoff coefficient estimated for the 10-year event, correlating a known hydrologic parameter with the target storm event. The rainfall intensities vary depending on the return frequency of the storm event under consideration. In general, these two frequency dependent parameters (rainfall intensity and runoff coefficient) increase as the return frequency increases while the drainage area remains constant.

These intensities, along with the total drainage area and runoff coefficient for each specific site, are translated into flow rates using the Rational Method. Since most sites are relatively small and highly impervious, the Rational Method is appropriate. Based on the runoff flow rates calculated for each intensity, operating rates within a proposed CDS are determined. Performance efficiency curve on defined sediment PSDs is applied to calculate solids removal efficiency. The relative removal efficiency at each operating rate is added to produce a net annual pollutant removal efficiency estimate.

Treatment Flow Rate

The inlet throat area is sized to ensure that the WQQ passes through the separation chamber at a water surface elevation equal to the crest of the diversion weir. The diversion weir bypasses excessive flows around the separation chamber, thus preventing re-suspension or re-entrainment of previously captured particles.

Hydraulic Capacity

The hydraulic capacity of a CDS system is determined by the length and height of the diversion weir and by the maximum allowable head in the system. Typical configurations allow hydraulic capacities of up to ten times the treatment flow rate. The crest of the diversion weir may be lowered and the inlet throat may be widened to increase the capacity of the system at a given water surface elevation. The unit is designed to meet project specific hydraulic requirements.

Performance

Full-Scale Laboratory Test Results

A full-scale CDS system (Model CDS2020-5B) was tested at the facility of University of Florida, Gainesville, FL. This CDS unit was evaluated under controlled laboratory conditions of influent flow rate and addition of sediment.

Two different gradations of silica sand material (UF Sediment & OK-110) were used in the CDS performance evaluation. The particle size distributions (PSDs) of the test materials were analyzed using standard method "Gradation ASTM D-422 "Standard Test Method for Particle-Size Analysis of Soils" by a certified laboratory.

UF Sediment is a mixture of three different products produced by the U.S. Silica Company: "Sil-Co-Sil 106", "#1 DRY" and "20/40 Oil Frac". Particle size distribution analysis shows that the UF Sediment has a very fine gradation ($d_{50} = 20$ to $30 \mu\text{m}$) covering a wide size range (Coefficient of Uniformity, C averaged at 10.6). In comparison with the hypothetical TSS gradation specified in the NJDEP (New Jersey Department of Environmental Protection) and NJCAT (New Jersey Corporation for Advanced Technology) protocol for lab testing, the UF Sediment covers a similar range of particle size but with a finer d_{50} (d_{50} for NJDEP is approximately $50 \mu\text{m}$) (NJDEP, 2003).

The OK-110 silica sand is a commercial product of U.S. Silica Sand. The particle size distribution analysis of this material, also included in Figure 1, shows that 99.9% of the OK-110 sand is finer than 250 microns, with a mean particle size (d_{50}) of 106 microns. The PSDs for the test material are shown in Figure 1.

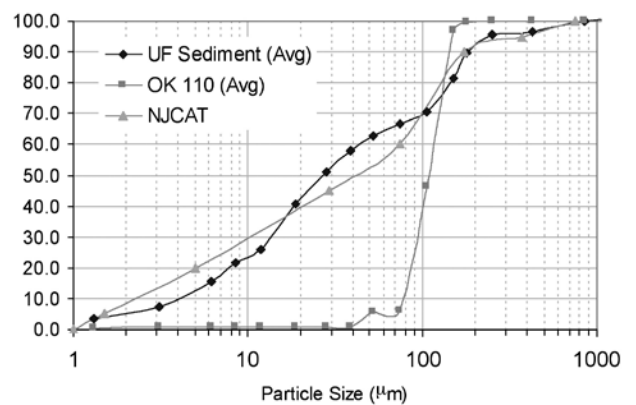

Figure 1. Particle size distributions

Tests were conducted to quantify the performance of a specific CDS unit (1.1 cfs (31.3-L/s) design capacity) at various flow rates, ranging from 1% up to 125% of the treatment design capacity of the unit, using the 2400 micron screen. All tests were conducted with controlled influent concentrations of approximately 200 mg/L. Effluent samples were taken at equal time intervals across the entire duration of each test run. These samples were then processed with a Dekaport Cone sample splitter to obtain representative sub-samples for Suspended Sediment Concentration (SSC) testing using ASTM D3977-97 "Standard Test Methods for Determining Sediment Concentration in Water Samples", and particle size distribution analysis.

Results and Modeling

Based on the data from the University of Florida, a performance model was developed for the CDS system. A regression analysis was used to develop a fitting curve representative of the scattered data points at various design flow rates. This model, which demonstrated good agreement with the laboratory data, can then be used to predict CDS system performance with respect

to SSC removal for any particle size gradation, assuming the particles are inorganic sandy-silt. Figure 2 shows CDS predictive performance for two typical particle size gradations (NJCAT gradation and OK-110 sand) as a function of operating rate.

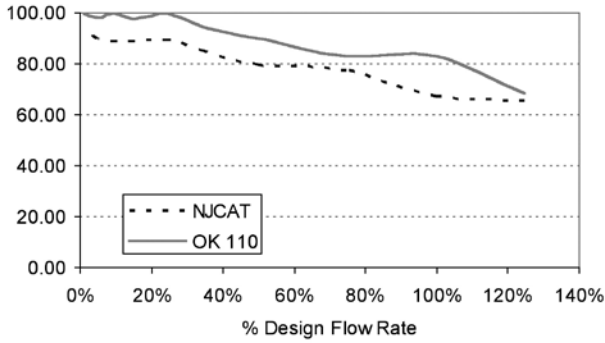

Figure 2. CDS stormwater treatment predictive performance for various particle gradations as a function of operating rate.

Many regulatory jurisdictions set a performance standard for hydrodynamic devices by stating that the devices shall be capable of achieving an 80% removal efficiency for particles having a mean particle size (d_{50}) of 125 microns (e.g. Washington State Department of Ecology — WASDOE - 2008). The model can be used to calculate the expected performance of such a PSD (shown in Figure 3). The model indicates (Figure 4) that the CDS system with 2400 micron screen achieves approximately 80% removal at the design (100%) flow rate, for this particle size distribution ($d_{50} = 125 \mu\text{m}$).

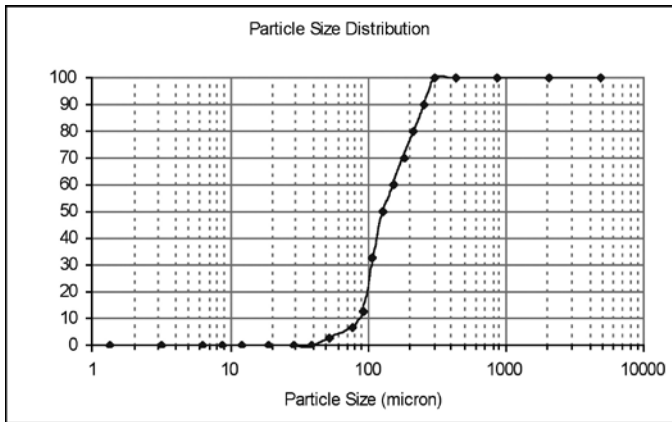

Figure 3. WASDOE PSD

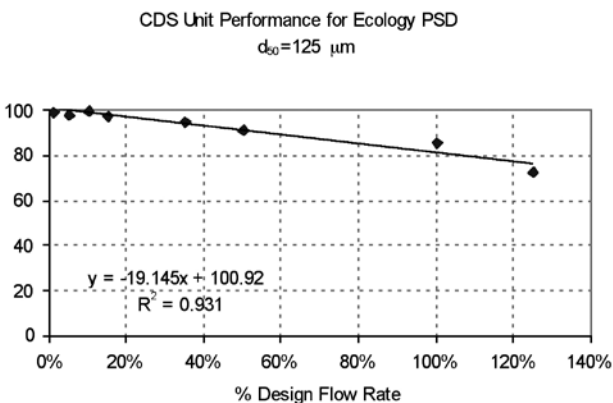

Figure 4. Modeled performance for WASDOE PSD.

Maintenance

The CDS system should be inspected at regular intervals and maintained when necessary to ensure optimum performance. The rate at which the system collects pollutants will depend more heavily on site activities than the size of the unit. For example, unstable soils or heavy winter sanding will cause the grit chamber to fill more quickly but regular sweeping of paved surfaces will slow accumulation.

Inspection

Inspection is the key to effective maintenance and is easily performed. Pollutant transport and deposition may vary from year to year and regular inspections will help ensure that the system is cleaned out at the appropriate time. At a minimum, inspections should be performed twice per year (e.g. spring and fall) however more frequent inspections may be necessary in climates where winter sanding operations may lead to rapid accumulations, or in equipment washdown areas. Installations should also be inspected more frequently where excessive amounts of trash are expected.

The visual inspection should ascertain that the system components are in working order and that there are no blockages or obstructions in the inlet and separation screen. The inspection should also quantify the accumulation of hydrocarbons, trash, and sediment in the system. Measuring pollutant accumulation can be done with a calibrated dipstick, tape measure or other measuring instrument. If absorbent material is used for enhanced removal of hydrocarbons, the level of discoloration of the sorbent material should also be identified



during inspection. It is useful and often required as part of an operating permit to keep a record of each inspection. A simple form for doing so is provided.

Access to the CDS unit is typically achieved through two manhole access covers. One opening allows for inspection and cleanout of the separation chamber (cylinder and screen) and isolated sump. The other allows for inspection and cleanout of sediment captured and retained outside the screen. For deep units, a single manhole access point would allow both sump cleanout and access outside the screen.

The CDS system should be cleaned when the level of sediment has reached 75% of capacity in the isolated sump or when an appreciable level of hydrocarbons and trash has accumulated. If absorbent material is used, it should be replaced when significant discoloration has occurred. Performance will not be impacted until 100% of the sump capacity is exceeded however it is recommended that the system be cleaned prior to that for easier removal of sediment. The level of sediment is easily determined by measuring from finished grade down to the top of the sediment pile. To avoid underestimating the level of sediment in the chamber, the measuring device must be lowered to the top of the sediment pile carefully. Particles at the top of the pile typically offer less resistance to the end of the rod than consolidated particles toward the bottom of the pile. Once this measurement is recorded, it should be compared to the as-built drawing for the unit to determine whether the height of the sediment pile off the bottom of the sump floor exceeds 75% of the total height of isolated sump.

Cleaning

Cleaning of a CDS system should be done during dry weather conditions when no flow is entering the system. The use of a vacuum truck is generally the most effective and convenient method of removing pollutants from the system. Simply remove the manhole covers and insert the vacuum hose into the sump. The system should be completely drained down and the sump fully evacuated of sediment. The area outside the screen should also be cleaned out if pollutant build-up exists in this area.

In installations where the risk of petroleum spills is small, liquid contaminants may not accumulate as quickly as sediment. However, the system should be cleaned out immediately in the event of an oil or gasoline spill. Motor oil and other hydrocarbons that accumulate on a more routine basis should be removed when an appreciable layer has been captured. To remove these pollutants, it may be preferable to use absorbent pads since they are usually less expensive to dispose than the oil/water emulsion that may be created by vacuuming the oily layer. Trash and debris can be netted out to separate it from the other pollutants. The screen should be cleaned to ensure it is free of trash and debris.

Manhole covers should be securely seated following cleaning activities to prevent leakage of runoff into the system from above and also to ensure that proper safety precautions have been followed. Confined space entry procedures need to be followed if physical access is required. Disposal of all material removed from the CDS system should be done in accordance with local regulations. In many jurisdictions, disposal of the sediments may be handled in the same manner as the disposal of sediments removed from catch basins or deep sump manholes. Check your local regulations for specific requirements on disposal.



CDS Model	Diameter		Distance from Water Surface to Top of Sediment Pile		Sediment Storage Capacity	
	ft	m	ft	m	y ³	m ³
CDS1515	3	0.9	3.0	0.9	0.5	0.4
CDS2015	4	1.2	3.0	0.9	0.9	0.7
CDS2015	5	1.5	3.0	0.9	1.3	1.0
CDS2020	5	1.5	3.5	1.1	1.3	1.0
CDS2025	5	1.5	4.0	1.2	1.3	1.0
CDS3020	6	1.8	4.0	1.2	2.1	1.6
CDS3025	6	1.8	4.0	1.2	2.1	1.6
CDS3030	6	1.8	4.6	1.4	2.1	1.6
CDS3035	6	1.8	5.0	1.5	2.1	1.6
CDS4030	8	2.4	4.6	1.4	5.6	4.3
CDS4040	8	2.4	5.7	1.7	5.6	4.3
CDS4045	8	2.4	6.2	1.9	5.6	4.3
CDS5640	10	3.0	6.3	1.9	8.7	6.7
CDS5653	10	3.0	7.7	2.3	8.7	6.7
CDS5668	10	3.0	9.3	2.8	8.7	6.7
CDS5678	10	3.0	10.3	3.1	8.7	6.7

Table 1: CDS Maintenance Indicators and Sediment Storage Capacities

Note: To avoid underestimating the volume of sediment in the chamber, carefully lower the measuring device to the top of the sediment pile. Finer silty particles at the top of the pile may be more difficult to feel with a measuring stick. These finer particles typically offer less resistance to the end of the rod than larger particles toward the bottom of the pile.



CDS Inspection & Maintenance Log

CDS Model: _____ Location: _____

Date	Water depth to sediment ¹	Floatable Layer Thickness ²	Describe Maintenance Performed	Maintenance Personnel	Comments

- 1. The water depth to sediment is determined by taking two measurements with a stadia rod: one measurement from the manhole opening to the top of the sediment pile and the other from the manhole opening to the water surface. If the difference between these measurements is less than the values listed in table 1 the system should be cleaned out. **Note: to avoid underestimating the volume of sediment in the chamber, the measuring device must be carefully lowered to the top of the sediment pile.**
- 2. For optimum performance, the system should be cleaned out when the floating hydrocarbon layer accumulates to an appreciable thickness. In the event of an oil spill, the system should be cleaned immediately.

SUPPORT

- Drawings and specifications are available at www.ContechES.com.
- Site-specific design support is available from our engineers.



800-338-1122

www.ContechES.com

©2017 Contech Engineered Solutions LLC, a QUIKRETE Company

Contech Engineered Solutions provides site solutions for the civil engineering industry. Contech's portfolio includes bridges, drainage, sanitary sewer, earth stabilization and stormwater treatment products. For information on other Contech division offerings, visit www.ContechES.com or call 800.338.1122

NOTHING IN THIS CATALOG SHOULD BE CONSTRUED AS A WARRANTY. APPLICATIONS SUGGESTED HEREIN ARE DESCRIBED ONLY TO HELP READERS MAKE THEIR OWN EVALUATIONS AND DECISIONS, AND ARE NEITHER GUARANTEES NOR WARRANTIES OF SUITABILITY FOR ANY APPLICATION. CONTECH MAKES NO WARRANTY WHATSOEVER, EXPRESS OR IMPLIED, RELATED TO THE APPLICATIONS, MATERIALS, COATINGS, OR PRODUCTS DISCUSSED HEREIN. ALL IMPLIED WARRANTIES OF MERCHANTABILITY AND ALL IMPLIED WARRANTIES OF FITNESS FOR ANY PARTICULAR PURPOSE ARE DISCLAIMED BY CONTECH. SEE CONTECH'S CONDITIONS OF SALE (AVAILABLE AT WWW.CONTECHES.COM/COS) FOR MORE INFORMATION.

The product(s) described may be protected by one or more of the following US patents: 5,322,629; 5,624,576; 5,707,527; 5,759,415; 5,788,848; 5,985,157; 6,027,639; 6,350,374; 6,406,218; 6,641,720; 6,511,595; 6,649,048; 6,991,114; 6,998,038; 7,186,058; 7,296,692; 7,297,266; related foreign patents or other patents pending.

ATTACHMENT F

HYDROLOGIC ANALYSIS – INPUT COMPUTATIONS

TR-55 Curve Number Calculations

Project: Slate Upper School
 Location: 5100 Ridge Road
North Haven, Connecticut
 By: FAB Date: 10/27/20 Revised: 12/10/2020 Date: _____
 Circle one: Present Developed _____ Watershed: EX WS10

Soil Name and Hydrologic Group (appendix A)	Cover Description (cover type, treatment, and hydrologic condition; percent impervious; unconnected/connected impervious area ratio)	CN Value ^{1.}			Area Acres Sq. Ft. %	Product of CN x Area
		Table 2-2	Figure 2-3	Figure 2-4		
B Soil	Woods - Good Condition	55			0.72	39.41
B Soil	Open Space - Good Condition	61			0.43	26.02
C Soil	Woods - Good Condition	70			1.29	90.17
C Soil	Open Space - Good Condition	74			1.77	130.64
C Soil	Gravel	89			0.01	0.65
D Soil	Woods - Good Condition	77			0.04	2.86
D Soil	Open Space - Good Condition	80			0.01	0.98
N/A	Existing Building	98			0.13	12.56
N/A	Existing Paved/Impervious	98			0.49	47.80
Totals =					4.87	351.09

(0.00761 sq mi)

$$\text{CN (weighted)} = \frac{\text{total product}}{\text{total area}} = \frac{351.09}{4.87} \text{ Use CN} = \boxed{72}$$

TR-55 Curve Number Calculations

Project: Slate Upper School
 Location: 5100 Ridge Road
North Haven, Connecticut
 By: FAB Date: 10/27/20 Revised: 2/16/2021 Date: _____
 Circle one: Present Developed Watershed: PR WS10

Soil Name and Hydrologic Group (appendix A)	Cover Description (cover type, treatment, and hydrologic condition; percent impervious; unconnected/connected impervious area ratio)	CN Value ^{1.}			Area Acres Sq. Ft. %	Product of CN x Area
		Table 2-2	Figure 2-3	Figure 2-4		
B Soil	Woods - Good Condition	55			0.22	12.19
B Soil	Open Space - Good Condition	61			0.20	12.25
C Soil	Woods - Good Condition	70			0.95	66.29
C Soil	Open Space - Good Condition	74			0.63	46.53
D Soil	Woods - Good Condition	77			0.05	3.74
D Soil	Open Space - Good Condition	80			0.03	2.29
N/A	Existing Building	98			0.07	6.64
N/A	Existing Paved/Impervious	98			0.11	10.77
N/A	Proposed Paved/Impervious	98			0.02	2.01
Totals =					2.27	162.68

(0.00355 sq mi)

$$\text{CN (weighted)} = \frac{\text{total product}}{\text{total area}} = \frac{162.68}{2.27} \quad \text{Use CN} = \boxed{71.5647}$$

TR-55 Curve Number Calculations

Project: Slate Upper School
 Location: 5100 Ridge Road
North Haven, Connecticut
 By: FAB Date: 10/27/20 Revised : 2/16/2021 Date: _____
 Circle one: Present **Developed** Watershed: PR WS11

Soil Name and Hydrologic Group (appendix A)	Cover Description (cover type, treatment, and hydrologic condition; percent impervious; unconnected/connected impervious area ratio)	CN Value ^{1.}			Area Acres Sq. Ft. %	Product of CN x Area
		Table 2-2	Figure 2-3	Figure 2-4		
B Soil	Open Space - Good Condition	61			0.05	3.13
C Soil	Open Space - Good Condition	74			0.71	52.60
N/A	Proposed Green Roof	88			0.07	6.19
N/A	Proposed Conventional Building	98			0.17	16.73
N/A	Proposed Paved/Impervious	98			0.28	27.20
Totals =					1.28	105.85

(0.00200 sq mi)

CN (weighted) = $\frac{\text{total product}}{\text{total area}}$ = $\frac{105.85}{1.28}$ Use CN = 83

TR-55 Curve Number Calculations

Project: Slate Upper School
 Location: 5100 Ridge Road
North Haven, Connecticut
 By: FAB Date: 12/10/20 Revised : 2/16/2021 Date: _____
 Circle one: Present **Developed** Watershed: PR WS12

Soil Name and Hydrologic Group (appendix A)	Cover Description (cover type, treatment, and hydrologic condition; percent impervious; unconnected/connected impervious area ratio)	CN Value ^{1.}			Area Acres Sq. Ft. %	Product of CN x Area
		Table 2-2	Figure 2-3	Figure 2-4		
B Soil	Woods - Good Condition	55			0.42	23.28
B Soil	Open Space - Good Condition	61			0.17	10.31
C Soil	Woods - Good Condition	70			0.08	5.38
C Soil	Open Space - Good Condition	74			0.08	5.76
N/A	Existing Paved/Impervious	98			0.04	4.26
N/A	Proposed Paved/Impervious	98			0.52	51.41
Totals =					1.32	100.42

(0.00206 sq mi)

CN (weighted) = $\frac{\text{total product}}{\text{total area}}$ = $\frac{100.42}{1.32}$ Use CN = 76

Time of Concentration (T_c) or Travel Time (T_t) Worksheet

Project: Slate Upper School By: FAB Date: 10/27/20
 Location: 5100 Ridge Road, North Haven, CT Checked: _____ Date: _____
 Circle one: Present Developed Watershed: EXWS 10
 Circle one: T_c T_t Subwatershed: _____

Sheet flow (applicable to T_c only)

	Segment ID	A-B	
1. Surface description (Table 3-1)		WOODS	
2. Manning's roughness coeff. for sheet flow, n (Table 3-1)		0.400	
3. Flow Length, L (< 300ft)	ft.	70.0	
4. Two-year 24-hr rainfall, P_2	in.	3.50	
5. Land slope, s	ft./ft.	0.045	
6. $T_t = \frac{0.007 (nL)^{0.8}}{P_2^{0.5} (s^{0.4})}$	hr.	0.186	= 0.186

Shallow concentrated flow (assume hyd. radius = depth of flow)

	Segment ID	B-C	C-D	D-E	E-F	
7. Surface description		WOODS	BIT	WOODS	GRASS	
8. Manning's roughness coeff., n		0.100	0.015	0.100	0.080	
9. Paved or unpaved		UNPVD	PVD	UNPVD	UNPVD	
10. Depth of flow, d (default values: d=.4 unpaved, d=.2 paved) ft.		0.40	0.20	0.40	0.40	
11. Flow Length, L	ft.	210.0	101.0	55.0	330.0	
12. Watercourse slope, s	ft./ft.	0.15	0.16	0.16	0.11	
13. Average velocity, $V = \frac{1.49}{n} (d^{2/3}) (s^{1/2})$	fps.	3.13	13.59	3.24	3.37	
14. $T_t = \frac{L}{3600 * V}$	hr.	0.019	+ 0.002	+ 0.005	+ 0.027	= 0.053

Channel flow

	Segment ID					
15. Channel Bottom width, b	ft.					
16. Horizontal side slope component, z (z horiz:1 vert)	ft.					
17. Depth of flow, d	ft.					
18. Cross sectional flow area, A (assume trapazoidal)	ft. ²					
19. Wetted perimeter, P_w	ft.					
20. Hydraulic Radius, $R = \frac{A}{P_w}$	ft.					
21. Channel slope, s	ft./ft.					
22. Manning's roughness coeff., n						
23. $V = \frac{1.49}{n} (R^{2/3}) (s^{1/2})$	fps.					
24. Flow length, L	ft.					
25. $T_t = \frac{L}{3600 * V}$	hr.				+ _____	= 0.000
26. Watershed or subarea T_c or T_t (add T_t in steps 6, 14 & 25)	hr.					0.239

Time of Concentration (T_c) or Travel Time (T_t) Worksheet

Project: Slate Upper School By: FAB Date: 10/27/20
 Location: 5100 Ridge Road, North Haven, CT Checked: _____ Date: _____
 Circle one: Present Developed Watershed: PRWS 10
 Circle one: T_c T_t Subwatershed: _____

Sheet flow (applicable to T_c only)

	Segment ID	A-B	
1. Surface description (Table 3-1)		WOODS	
2. Manning's roughness coeff. for sheet flow, n (Table 3-1)		0.400	
3. Flow Length, L (< 300ft)	ft.	70.0	
4. Two-year 24-hr rainfall, P_2	in.	3.50	
5. Land slope, s	ft./ft.	0.045	
6. $T_t = \frac{0.007 (nL)^{0.8}}{P_2^{0.5} (s^{0.4})}$	hr.	0.186	= 0.186

Shallow concentrated flow (assume hyd. radius = depth of flow)

	Segment ID	B-C	C-D	D-E	E-F	
7. Surface description		WOODS	BIT	WOODS	GRASS	
8. Manning's roughness coeff., n		0.100	0.015	0.100	0.080	
9. Paved or unpaved		UNPVD	PVD	UNPVD	UNPVD	
10. Depth of flow, d (default values: d=.4 unpaved, d=.2 paved) ft.		0.40	0.20	0.40	0.40	
11. Flow Length, L	ft.	210.0	101.0	25.0	10.0	
12. Watercourse slope, s	ft./ft.	0.15	0.16	0.16	0.30	
13. Average velocity, $V = \frac{1.49}{n} (d^{2/3})(s^{1/2})$	fps.	3.13	13.59	3.24	5.54	
14. $T_t = \frac{L}{3600 * V}$	hr.	0.019	+ 0.002	+ 0.002	+ 0.001	= 0.023

Channel flow

	Segment ID	F-G				
15. Channel Bottom width, b	ft.	12" HDPE				
16. Horizontal side slope component, z (z horiz:1 vert)	ft.	--				
17. Depth of flow, d	ft.	FULL				
18. Cross sectional flow area, A (assume trapazoidal)	ft. ²	0.79				
19. Wetted perimeter, P_w	ft.	3.14				
20. Hydraulic Radius, $R = \frac{A}{P_w}$	ft.	0.25				
21. Channel slope, s	ft./ft.	0.07				
22. Manning's roughness coeff., n		0.012				
23. $V = \frac{1.49}{n} (R^{2/3})(s^{1/2})$	fps.	13.09				
24. Flow length, L	ft.	465.0				
25. $T_t = \frac{L}{3600 * V}$	hr.	0.010			+ 0.010	= 0.010
26. Watershed or subarea T_c or T_t (add T_t in steps 6, 14 & 25)	hr.					0.219

Time of Concentration (T_c) or Travel Time (T_t) Worksheet

Project: Slate Upper School
 Location: 5100 Ridge Road, North Haven, CT
 Circle one: Present Developed
 Circle one: T_c T_t

By: FAB Date: Rev 12/10/20
 Checked: _____ Date: _____
 Watershed: PRWS 11
 Subwatershed: _____

Sheet flow (applicable to T_c only)

	Segment ID	A-B
1. Surface description (Table 3-1)		GRASS
2. Manning's roughness coeff. for sheet flow, n (Table 3-1)		0.240
3. Flow Length, L (< 300ft)	ft.	65.0
4. Two-year 24-hr rainfall, P_2	in.	3.50
5. Land slope, s	ft./ft.	0.060
6. $T_t = \frac{0.007 (nL)^{0.8}}{P_2^{0.5} (s^{0.4})}$	hr.	0.104 = 0.104

Shallow concentrated flow (assume hyd. radius = depth of flow)

	Segment ID	B-C			
7. Surface description		GRASS			
8. Manning's roughness coeff., n		0.080			
9. Paved or unpaved		UNPVD			
10. Depth of flow, d (default values: d=.4 unpaved, d=.2 paved) ft.		0.40			
11. Flow Length, L	ft.	20.0			
12. Watercourse slope, s	ft./ft.	0.30			
13. Average velocity, $V = \frac{1.49}{n} (d^{2/3}) (s^{1/2})$	fps.	5.54			
14. $T_t = \frac{L}{3600 * V}$	hr.	0.001 +		+	
					= 0.001

Channel flow

	Segment ID	C-D			
15. Channel Bottom width, b	ft.	15" HDPE			
16. Horizontal side slope component, z (z horiz:1 vert)	ft.	--			
17. Depth of flow, d	ft.	FULL			
18. Cross sectional flow area, A (assume trapezoidal)	ft. ²	1.23			
19. Wetted perimeter, P_w	ft.	3.93			
20. Hydraulic Radius, $R = \frac{A}{P_w}$	ft.	0.31			
21. Channel slope, s	ft./ft.	0.05			
22. Manning's roughness coeff., n		0.012			
23. $V = \frac{1.49}{n} (R^{2/3}) (s^{1/2})$	fps.	12.80			
24. Flow length, L	ft.	160.0			
25. $T_t = \frac{L}{3600 * V}$	hr.	0.003		+	
26. Watershed or subarea T_c or T_t (add T_t in steps 6, 14 & 25)	hr.				= 0.003
					0.108

Time of Concentration (T_c) or Travel Time (T_t) Worksheet

Project: Slate Upper School By: FAB Date: Rev 2/16/21
 Location: 5100 Ridge Road, North Haven, CT Checked: _____ Date: _____
 Circle one: Present Developed Watershed: PRWS 12
 Circle one: T_c T_t Subwatershed: _____

Sheet flow (applicable to T_c only)

	Segment ID	A-B	
1. Surface description (Table 3-1)		WOODS	
2. Manning's roughness coeff. for sheet flow, n (Table 3-1)		0.400	
3. Flow Length, L (< 300ft)	ft.	65.0	
4. Two-year 24-hr rainfall, P_2	in.	3.50	
5. Land slope, s	ft./ft.	0.045	
6. $T_t = \frac{0.007 (nL)^{0.8}}{P_2^{0.5} (s^{0.4})}$	hr.	0.175	= 0.175

Shallow concentrated flow (assume hyd. radius = depth of flow)

	Segment ID	B-C	C-D	D-E	E-F	F-G	
7. Surface description		WOODS	BIT	WOODS	GRASS	BIT	
8. Manning's roughness coeff., n		0.100	0.015	0.100	0.080	0.015	
9. Paved or unpaved		UNPVD	PVD	UNPVD	UNPVD	PVD	
10. Depth of flow, d (default values: d=.4 unpaved, d=.2 paved) ft.		0.40	0.20	0.40	0.40	0.20	
11. Flow Length, L	ft.	270.0	38.0	25.0	40.0	100.0	
12. Watercourse slope, s	ft./ft.	0.17	0.16	0.16	0.20	0.03	
13. Average velocity, $V = \frac{1.49}{n} (d^{2/3}) (s^{1/2})$	fps.	3.34	13.59	3.24	4.52	5.88	
14. $T_t = \frac{L}{3600 * V}$	hr.	0.022	+ 0.001	+ 0.002	+ 0.002	+ 0.005	= 0.033

Channel flow

	Segment ID					
15. Channel Bottom width, b	ft.					
16. Horizontal side slope component, z (z horiz:1 vert)	ft.					
17. Depth of flow, d	ft.					
18. Cross sectional flow area, A (assume trapazoidal)	ft. ²					
19. Wetted perimeter, P_w	ft.					
20. Hydraulic Radius, $R = \frac{A}{P_w}$	ft.					
21. Channel slope, s	ft./ft.					
22. Manning's roughness coeff., n						
23. $V = \frac{1.49}{n} (R^{2/3}) (s^{1/2})$	fps.					
24. Flow length, L	ft.					
25. $T_t = \frac{L}{3600 * V}$	hr.				+	= 0.000
26. Watershed or subarea T_c or T_t (add T_t in steps 6, 14 & 25)	hr.					0.208



NOAA Atlas 14, Volume 10, Version 3
Location name: North Haven, Connecticut, USA*
Latitude: 41.4214°, Longitude: -72.8826°
Elevation: 181.97 ft**
 * source: ESRI Maps
 ** source: USGS



POINT PRECIPITATION FREQUENCY ESTIMATES

Sanja Perica, Sandra Pavlovic, Michael St. Laurent, Carl Trypaluk, Dale Unruh, Orlan Wilhite

NOAA, National Weather Service, Silver Spring, Maryland

[PF_tabular](#) | [PF_graphical](#) | [Maps & aeriels](#)

PF tabular

PDS-based point precipitation frequency estimates with 90% confidence intervals (in inches)¹										
Duration	Average recurrence interval (years)									
	1	2	5	10	25	50	100	200	500	1000
5-min	0.341 (0.262-0.429)	0.413 (0.317-0.520)	0.531 (0.405-0.671)	0.628 (0.477-0.799)	0.762 (0.562-1.02)	0.862 (0.625-1.18)	0.968 (0.684-1.38)	1.09 (0.730-1.60)	1.26 (0.818-1.92)	1.41 (0.891-2.19)
10-min	0.483 (0.371-0.608)	0.585 (0.448-0.737)	0.751 (0.574-0.951)	0.889 (0.676-1.13)	1.08 (0.797-1.44)	1.22 (0.885-1.67)	1.37 (0.969-1.96)	1.54 (1.03-2.26)	1.79 (1.16-2.72)	1.99 (1.26-3.11)
15-min	0.569 (0.436-0.715)	0.688 (0.528-0.867)	0.883 (0.674-1.12)	1.05 (0.795-1.33)	1.27 (0.937-1.70)	1.44 (1.04-1.97)	1.61 (1.14-2.31)	1.81 (1.22-2.66)	2.11 (1.36-3.21)	2.35 (1.49-3.65)
30-min	0.790 (0.606-0.993)	0.954 (0.731-1.20)	1.22 (0.934-1.55)	1.45 (1.10-1.84)	1.75 (1.29-2.34)	1.98 (1.44-2.72)	2.23 (1.57-3.18)	2.50 (1.68-3.67)	2.91 (1.88-4.43)	3.24 (2.05-5.05)
60-min	1.01 (0.775-1.27)	1.22 (0.935-1.54)	1.56 (1.19-1.97)	1.85 (1.40-2.35)	2.24 (1.65-2.99)	2.53 (1.83-3.47)	2.84 (2.01-4.06)	3.19 (2.14-4.67)	3.71 (2.40-5.64)	4.13 (2.62-6.44)
2-hr	1.33 (1.03-1.66)	1.59 (1.23-1.99)	2.01 (1.55-2.53)	2.37 (1.81-2.99)	2.85 (2.12-3.79)	3.21 (2.34-4.37)	3.60 (2.56-5.11)	4.04 (2.72-5.87)	4.68 (3.04-7.08)	5.22 (3.31-8.07)
3-hr	1.55 (1.20-1.93)	1.84 (1.43-2.30)	2.33 (1.80-2.91)	2.73 (2.10-3.44)	3.29 (2.45-4.35)	3.70 (2.71-5.02)	4.14 (2.95-5.87)	4.65 (3.14-6.74)	5.40 (3.51-8.13)	6.02 (3.83-9.28)
6-hr	1.97 (1.54-2.43)	2.35 (1.83-2.91)	2.98 (2.32-3.70)	3.50 (2.70-4.37)	4.21 (3.16-5.55)	4.75 (3.50-6.41)	5.32 (3.82-7.50)	5.99 (4.06-8.62)	6.98 (4.55-10.4)	7.81 (4.98-12.0)
12-hr	2.43 (1.91-2.98)	2.93 (2.30-3.61)	3.76 (2.94-4.64)	4.44 (3.46-5.52)	5.38 (4.07-7.05)	6.08 (4.51-8.17)	6.83 (4.95-9.60)	7.73 (5.26-11.1)	9.09 (5.95-13.5)	10.2 (6.55-15.6)
24-hr	2.85 (2.26-3.48)	3.50 (2.77-4.27)	4.56 (3.59-5.58)	5.44 (4.26-6.71)	6.65 (5.06-8.67)	7.54 (5.64-10.1)	8.51 (6.22-12.0)	9.71 (6.62-13.8)	11.6 (7.59-17.1)	13.2 (8.45-19.9)
2-day	3.21 (2.56-3.89)	4.01 (3.19-4.86)	5.31 (4.21-6.46)	6.39 (5.04-7.82)	7.87 (6.05-10.2)	8.96 (6.76-12.0)	10.2 (7.51-14.3)	11.7 (8.01-16.6)	14.2 (9.33-20.8)	16.3 (10.5-24.5)
3-day	3.49 (2.79-4.20)	4.36 (3.49-5.27)	5.80 (4.62-7.03)	6.99 (5.54-8.52)	8.62 (6.65-11.2)	9.82 (7.44-13.1)	11.1 (8.27-15.6)	12.9 (8.82-18.1)	15.6 (10.3-22.9)	18.1 (11.6-27.0)
4-day	3.74 (3.00-4.50)	4.67 (3.75-5.63)	6.20 (4.95-7.49)	7.46 (5.93-9.08)	9.20 (7.11-11.9)	10.5 (7.96-13.9)	11.9 (8.84-16.6)	13.7 (9.42-19.3)	16.6 (11.0-24.3)	19.2 (12.4-28.6)
7-day	4.46 (3.60-5.33)	5.49 (4.43-6.58)	7.18 (5.78-8.63)	8.58 (6.86-10.4)	10.5 (8.16-13.5)	11.9 (9.09-15.7)	13.5 (10.0-18.7)	15.5 (10.7-21.6)	18.6 (12.3-26.9)	21.3 (13.8-31.6)
10-day	5.18 (4.20-6.17)	6.27 (5.08-7.48)	8.05 (6.49-9.63)	9.52 (7.64-11.5)	11.6 (8.99-14.7)	13.1 (9.95-17.1)	14.7 (10.9-20.2)	16.7 (11.6-23.2)	19.8 (13.2-28.7)	22.5 (14.6-33.3)
20-day	7.40 (6.04-8.75)	8.57 (6.99-10.2)	10.5 (8.52-12.5)	12.1 (9.75-14.4)	14.3 (11.1-17.9)	15.9 (12.1-20.5)	17.6 (13.0-23.7)	19.6 (13.7-27.0)	22.5 (15.0-32.2)	24.9 (16.2-36.5)
30-day	9.26 (7.60-10.9)	10.5 (8.58-12.3)	12.4 (10.2-14.7)	14.1 (11.4-16.8)	16.3 (12.8-20.4)	18.1 (13.8-23.0)	19.8 (14.6-26.3)	21.7 (15.2-29.8)	24.4 (16.3-34.7)	26.5 (17.2-38.6)
45-day	11.6 (9.53-13.6)	12.8 (10.5-15.1)	14.9 (12.2-17.5)	16.5 (13.5-19.6)	18.9 (14.8-23.3)	20.7 (15.8-26.1)	22.5 (16.5-29.4)	24.3 (17.0-33.1)	26.6 (17.9-37.7)	28.4 (18.5-41.3)
60-day	13.5 (11.1-15.8)	14.8 (12.2-17.3)	16.9 (13.9-19.8)	18.6 (15.2-22.0)	21.0 (16.5-25.8)	22.8 (17.5-28.7)	24.7 (18.1-32.0)	26.4 (18.6-35.8)	28.5 (19.2-40.3)	30.0 (19.6-43.5)

¹ Precipitation frequency (PF) estimates in this table are based on frequency analysis of partial duration series (PDS). Numbers in parenthesis are PF estimates at lower and upper bounds of the 90% confidence interval. The probability that precipitation frequency estimates (for a given duration and average recurrence interval) will be greater than the upper bound (or less than the lower bound) is 5%. Estimates at upper bounds are not checked against probable maximum precipitation (PMP) estimates and may be higher than currently valid PMP values. Please refer to NOAA Atlas 14 document for more information.

[Back to Top](#)

PF graphical

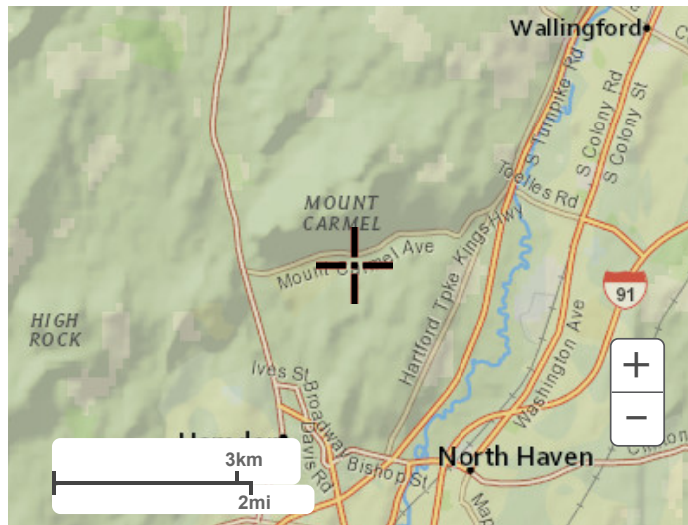

Large scale terrain



Large scale map

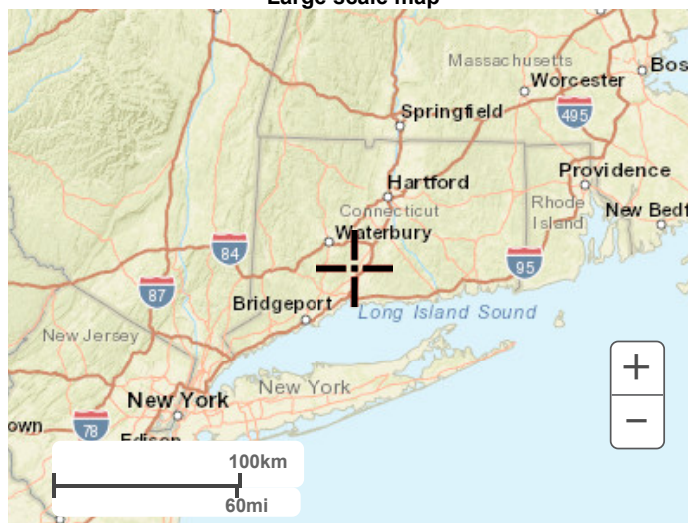

Large scale aerial

ATTACHMENT G

HYDROLOGIC ANALYSIS – COMPUTER MODEL RESULTS

Slate Upper School
5100 Ridge Road – North Haven, CT
#6156-03-07

Impervious Coverage Calculations:

- Existing Conditions:

Within property limits: 0.383 acres

Off property along Ridge Road frontage: 0.018 acres

=> Total Existing: 0.401 acres

- Proposed Conditions:

Within property limits: 0.943 acres

Off property along Ridge Road frontage: 0.036 acres

Ridge Road widening: 0.014 acres

=> Total Proposed: 0.993 acres

Hydrographs Peak Flowrate Summary (cfs) Existing vs. Proposed

<i>Storm Event</i>	1yr		2yr		10yr		25yr		50yr		100yr	
	Exist	Prop	Exist	Prop	Exist	Prop	Exist	Prop	Exist	Prop	Exist	Prop
Point of Analysis A	2.9	2.8	4.7	4.4	11.3	11.2	15.9	15.9	19.3	19.2	23.1	22.7
DET 110 W.S. Elev. (ft.) Top of Berm Elev. = 158.8	--	157.0	--	157.2	--	157.7	--	157.7	--	157.8	--	157.8
DET 120 W.S. Elev. (ft.) Top of Stone Elev. = 177.0	--	171.5	--	171.8	--	173.4	--	174.5	--	175.5	--	175.9

Study Area

A

Description

Wetland System - Northwest

Watershed Model Schematic

Hydraflow Hydrographs Extension for Autodesk® Civil 3D® 2019 by Autodesk, Inc. v2020

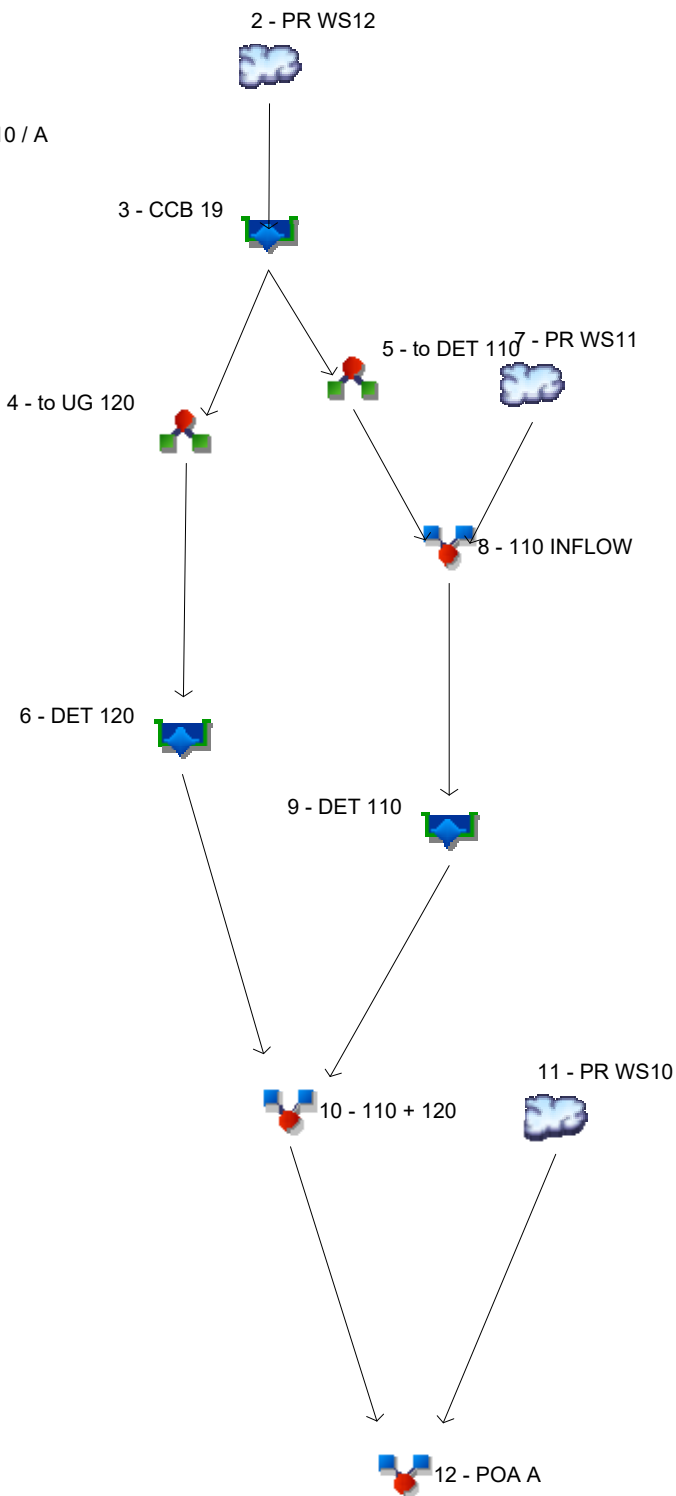

Legend

Hyd.	Origin	Description
1	SCS Runoff	EXWS-10 / A
2	SCS Runoff	PR WS12
3	Reservoir	CCB 19
4	Diversion1	to UG 120
5	Diversion2	to DET 110
6	Reservoir	DET 120
7	SCS Runoff	PR WS11
8	Combine	110 INFLOW
9	Reservoir	DET 110
10	Combine	110 + 120
11	SCS Runoff	PR WS10
12	Combine	POA A

Watershed Model Schematic.....	1
Hydrograph Return Period Recap.....	2
1 - Year	
Summary Report.....	3
2 - Year	
Summary Report.....	4
10 - Year	
Summary Report.....	5
25 - Year	
Summary Report.....	6
50 - Year	
Summary Report.....	7
100 - Year	
Summary Report.....	8

Hydrograph Return Period Recap

Hydroflow Hydrographs Extension for Autodesk® Civil 3D® 2019 by Autodesk, Inc. v2020

Hyd. No.	Hydrograph type (origin)	Inflow hyd(s)	Peak Outflow (cfs)								Hydrograph Description
			1-yr	2-yr	3-yr	5-yr	10-yr	25-yr	50-yr	100-yr	
1	SCS Runoff	-----	2.853	4.713	-----	-----	11.34	15.87	19.30	23.10	EXWS-10 / A
2	SCS Runoff	-----	1.044	1.616	-----	-----	3.534	4.806	5.758	6.804	PR WS12
3	Reservoir	2	1.039	1.613	-----	-----	3.534	4.805	5.761	6.806	CCB 19
4	Diversion1	3	0.000	0.216	-----	-----	1.711	2.750	3.493	4.285	to UG 120
5	Diversion2	3	1.039	1.397	-----	-----	1.823	2.055	2.267	2.521	to DET 110
6	Reservoir	4	0.000	0.141	-----	-----	0.837	1.643	2.117	3.972	DET 120
7	SCS Runoff	-----	1.731	2.435	-----	-----	4.634	6.028	7.054	8.169	PR WS11
8	Combine	5, 7	2.650	3.771	-----	-----	6.410	8.011	9.230	10.58	110 INFLOW
9	Reservoir	8	1.574	2.187	-----	-----	5.327	7.591	8.768	10.11	DET 110
10	Combine	6, 9	1.574	2.287	-----	-----	6.078	8.482	10.23	11.94	110 + 120
11	SCS Runoff	-----	1.330	2.197	-----	-----	5.285	7.396	8.995	10.77	PR WS10
12	Combine	10, 11	2.781	4.352	-----	-----	11.21	15.88	19.22	22.71	POA A

Hydrograph Summary Report

Hydraflow Hydrographs Extension for Autodesk® Civil 3D® 2019 by Autodesk, Inc. v2020

Hyd. No.	Hydrograph type (origin)	Peak flow (cfs)	Time interval (min)	Time to Peak (min)	Hyd. volume (acft)	Inflow hyd(s)	Maximum elevation (ft)	Total strge used (acft)	Hydrograph Description	
1	SCS Runoff	2.853	3	732	0.292	-----	-----	-----	EXWS-10 / A	
2	SCS Runoff	1.044	3	729	0.101	-----	-----	-----	PR WS12	
3	Reservoir	1.039	3	732	0.101	2	173.95	0.000	CCB 19	
4	Diversion1	0.000	3	n/a	0.000	3	-----	-----	to UG 120	
5	Diversion2	1.039	3	732	0.101	3	-----	-----	to DET 110	
6	Reservoir	0.000	3	n/a	0.000	4	171.50	0.000	DET 120	
7	SCS Runoff	1.731	3	726	0.133	-----	-----	-----	PR WS11	
8	Combine	2.650	3	726	0.233	5, 7	-----	-----	110 INFLOW	
9	Reservoir	1.574	3	741	0.233	8	156.98	0.045	DET 110	
10	Combine	1.574	3	741	0.233	6, 9	-----	-----	110 + 120	
11	SCS Runoff	1.330	3	732	0.136	-----	-----	-----	PR WS10	
12	Combine	2.781	3	735	0.369	10, 11	-----	-----	POA A	
SU-Model03.gpw					Return Period: 1 Year			Tuesday, 02 / 16 / 2021		

Hydrograph Summary Report

Hydraflow Hydrographs Extension for Autodesk® Civil 3D® 2019 by Autodesk, Inc. v2020

Hyd. No.	Hydrograph type (origin)	Peak flow (cfs)	Time interval (min)	Time to Peak (min)	Hyd. volume (acft)	Inflow hyd(s)	Maximum elevation (ft)	Total strge used (acft)	Hydrograph Description	
1	SCS Runoff	4.713	3	729	0.455	-----	-----	-----	EXWS-10 / A	
2	SCS Runoff	1.616	3	729	0.150	-----	-----	-----	PR WS12	
3	Reservoir	1.613	3	729	0.150	2	174.24	0.000	CCB 19	
4	Diversion1	0.216	3	729	0.003	3	-----	-----	to UG 120	
5	Diversion2	1.397	3	729	0.147	3	-----	-----	to DET 110	
6	Reservoir	0.141	3	735	0.003	4	171.75	0.001	DET 120	
7	SCS Runoff	2.435	3	726	0.186	-----	-----	-----	PR WS11	
8	Combine	3.771	3	726	0.333	5, 7	-----	-----	110 INFLOW	
9	Reservoir	2.187	3	741	0.333	8	157.24	0.063	DET 110	
10	Combine	2.287	3	738	0.336	6, 9	-----	-----	110 + 120	
11	SCS Runoff	2.197	3	729	0.212	-----	-----	-----	PR WS10	
12	Combine	4.352	3	732	0.548	10, 11	-----	-----	POA A	
SU-Model03.gpw					Return Period: 2 Year			Tuesday, 02 / 16 / 2021		

Hydrograph Summary Report

Hydraflow Hydrographs Extension for Autodesk® Civil 3D® 2019 by Autodesk, Inc. v2020

Hyd. No.	Hydrograph type (origin)	Peak flow (cfs)	Time interval (min)	Time to Peak (min)	Hyd. volume (acft)	Inflow hyd(s)	Maximum elevation (ft)	Total strge used (acft)	Hydrograph Description	
1	SCS Runoff	11.34	3	729	1.032	-----	-----	-----	EXWS-10 / A	
2	SCS Runoff	3.534	3	729	0.319	-----	-----	-----	PR WS12	
3	Reservoir	3.534	3	729	0.319	2	174.71	0.000	CCB 19	
4	Diversion1	1.711	3	729	0.041	3	-----	-----	to UG 120	
5	Diversion2	1.823	3	729	0.278	3	-----	-----	to DET 110	
6	Reservoir	0.837	3	738	0.041	4	173.36	0.019	DET 120	
7	SCS Runoff	4.634	3	726	0.357	-----	-----	-----	PR WS11	
8	Combine	6.410	3	726	0.636	5, 7	-----	-----	110 INFLOW	
9	Reservoir	5.327	3	732	0.635	8	157.65	0.092	DET 110	
10	Combine	6.078	3	732	0.676	6, 9	-----	-----	110 + 120	
11	SCS Runoff	5.285	3	729	0.481	-----	-----	-----	PR WS10	
12	Combine	11.21	3	729	1.157	10, 11	-----	-----	POA A	
SU-Model03.gpw					Return Period: 10 Year			Tuesday, 02 / 16 / 2021		

Hydrograph Summary Report

Hydraflow Hydrographs Extension for Autodesk® Civil 3D® 2019 by Autodesk, Inc. v2020

Hyd. No.	Hydrograph type (origin)	Peak flow (cfs)	Time interval (min)	Time to Peak (min)	Hyd. volume (acft)	Inflow hyd(s)	Maximum elevation (ft)	Total strge used (acft)	Hydrograph Description	
1	SCS Runoff	15.87	3	729	1.434	-----	-----	-----	EXWS-10 / A	
2	SCS Runoff	4.806	3	729	0.434	-----	-----	-----	PR WS12	
3	Reservoir	4.805	3	729	0.434	2	175.03	0.001	CCB 19	
4	Diversion1	2.750	3	729	0.077	3	-----	-----	to UG 120	
5	Diversion2	2.055	3	729	0.357	3	-----	-----	to DET 110	
6	Reservoir	1.643	3	738	0.077	4	174.51	0.033	DET 120	
7	SCS Runoff	6.028	3	726	0.470	-----	-----	-----	PR WS11	
8	Combine	8.011	3	726	0.827	5, 7	-----	-----	110 INFLOW	
9	Reservoir	7.591	3	729	0.827	8	157.72	0.098	DET 110	
10	Combine	8.482	3	729	0.904	6, 9	-----	-----	110 + 120	
11	SCS Runoff	7.396	3	729	0.668	-----	-----	-----	PR WS10	
12	Combine	15.88	3	729	1.572	10, 11	-----	-----	POA A	
SU-Model03.gpw					Return Period: 25 Year			Tuesday, 02 / 16 / 2021		

Hydrograph Summary Report

Hydraflow Hydrographs Extension for Autodesk® Civil 3D® 2019 by Autodesk, Inc. v2020

Hyd. No.	Hydrograph type (origin)	Peak flow (cfs)	Time interval (min)	Time to Peak (min)	Hyd. volume (acft)	Inflow hyd(s)	Maximum elevation (ft)	Total strge used (acft)	Hydrograph Description	
1	SCS Runoff	19.30	3	729	1.742	-----	-----	-----	EXWS-10 / A	
2	SCS Runoff	5.758	3	729	0.522	-----	-----	-----	PR WS12	
3	Reservoir	5.761	3	729	0.522	2	175.37	0.001	CCB 19	
4	Diversion1	3.493	3	729	0.106	3	-----	-----	to UG 120	
5	Diversion2	2.267	3	729	0.415	3	-----	-----	to DET 110	
6	Reservoir	2.117	3	738	0.106	4	175.52	0.044	DET 120	
7	SCS Runoff	7.054	3	726	0.554	-----	-----	-----	PR WS11	
8	Combine	9.230	3	726	0.969	5, 7	-----	-----	110 INFLOW	
9	Reservoir	8.768	3	729	0.969	8	157.76	0.101	DET 110	
10	Combine	10.23	3	729	1.075	6, 9	-----	-----	110 + 120	
11	SCS Runoff	8.995	3	729	0.812	-----	-----	-----	PR WS10	
12	Combine	19.22	3	729	1.887	10, 11	-----	-----	POA A	
SU-Model03.gpw					Return Period: 50 Year			Tuesday, 02 / 16 / 2021		

Hydrograph Summary Report

Hydraflow Hydrographs Extension for Autodesk® Civil 3D® 2019 by Autodesk, Inc. v2020

Hyd. No.	Hydrograph type (origin)	Peak flow (cfs)	Time interval (min)	Time to Peak (min)	Hyd. volume (acft)	Inflow hyd(s)	Maximum elevation (ft)	Total strge used (acft)	Hydrograph Description	
1	SCS Runoff	23.10	3	729	2.088	-----	-----	-----	EXWS-10 / A	
2	SCS Runoff	6.804	3	729	0.619	-----	-----	-----	PR WS12	
3	Reservoir	6.806	3	729	0.619	2	175.79	0.001	CCB 19	
4	Diversion1	4.285	3	729	0.140	3	-----	-----	to UG 120	
5	Diversion2	2.521	3	729	0.479	3	-----	-----	to DET 110	
6	Reservoir	3.972	3	735	0.140	4	175.88	0.046	DET 120	
7	SCS Runoff	8.169	3	726	0.647	-----	-----	-----	PR WS11	
8	Combine	10.58	3	726	1.125	5, 7	-----	-----	110 INFLOW	
9	Reservoir	10.11	3	726	1.125	8	157.80	0.104	DET 110	
10	Combine	11.94	3	729	1.265	6, 9	-----	-----	110 + 120	
11	SCS Runoff	10.77	3	729	0.973	-----	-----	-----	PR WS10	
12	Combine	22.71	3	729	2.238	10, 11	-----	-----	POA A	
SU-Model03.gpw					Return Period: 100 Year			Tuesday, 02 / 16 / 2021		

Pond Report

Pond No. 1 - DET 110

Pond Data

Contours -User-defined contour areas. Conic method used for volume calculation. Begining Elevation = 156.20 ft

Stage / Storage Table

Stage (ft)	Elevation (ft)	Contour area (sqft)	Incr. Storage (acft)	Total storage (acft)
0.00	156.20	2,250	0.000	0.000
0.30	156.50	2,400	0.016	0.016
0.80	157.00	2,825	0.030	0.046
1.30	157.50	3,300	0.035	0.081
1.80	158.00	3,750	0.040	0.122
2.30	158.50	4,275	0.046	0.168
2.80	159.00	4,800	0.052	0.220

Culvert / Orifice Structures

	[A]	[B]	[C]	[PrfRsr]
Rise (in)	= 18.00	6.00	6.00	0.00
Span (in)	= 18.00	6.00	6.00	0.00
No. Barrels	= 1	2	1	0
Invert El. (ft)	= 153.00	156.20	156.70	0.00
Length (ft)	= 115.00	0.00	0.00	0.00
Slope (%)	= 2.17	0.00	0.00	n/a
N-Value	= .012	.013	.013	n/a
Orifice Coeff.	= 0.60	0.60	0.60	0.60
Multi-Stage	= n/a	Yes	Yes	No

Weir Structures

	[A]	[B]	[C]	[D]
Crest Len (ft)	= 14.00	0.00	30.00	0.00
Crest El. (ft)	= 157.50	0.00	158.80	0.00
Weir Coeff.	= 3.33	3.33	2.60	3.33
Weir Type	= 1	---	Cip/ti	---
Multi-Stage	= Yes	No	No	No
Exfil.(in/hr)	= 0.000 (by Wet area)			
TW Elev. (ft)	= 0.00			

Note: Culvert/Orifice outflows are analyzed under inlet (ic) and outlet (oc) control. Weir risers checked for orifice conditions (ic) and submergence (s).

Stage / Storage / Discharge Table

Stage ft	Storage acft	Elevation ft	Civ A cfs	Civ B cfs	Civ C cfs	PrfRsr cfs	Wr A cfs	Wr B cfs	Wr C cfs	Wr D cfs	Exfil cfs	User cfs	Total cfs
0.00	0.000	156.20	0.00	0.00	0.00	---	0.00	---	0.00	---	---	---	0.000
0.30	0.016	156.50	13.32 ic	0.46 ic	0.00	---	0.00	---	0.00	---	---	---	0.460
0.80	0.046	157.00	13.32 ic	1.40 ic	0.23 ic	---	0.00	---	0.00	---	---	---	1.632
1.30	0.081	157.50	13.32 ic	1.94 ic	0.70 ic	---	0.00	---	0.00	---	---	---	2.638
1.80	0.122	158.00	16.83 ic	1.09 ic	0.55 ic	---	15.19 s	---	0.00	---	---	---	16.83
2.30	0.168	158.50	18.43 ic	0.44 ic	0.22 ic	---	17.77 s	---	0.00	---	---	---	18.43
2.80	0.220	159.00	19.46 ic	0.27 ic	0.13 ic	---	19.02 s	---	6.98	---	---	---	26.40

Pond Report

Pond No. 2 - DET 120

Pond Data

UG Chambers -Invert elev. = 172.25 ft, Rise x Span = 3.75 x 6.42 ft, Barrel Len = 7.17 ft, No. Barrels = 12, Slope = 0.00%, Headers = No

Encasement -Invert elev. = 171.50 ft, Width = 7.17 ft, Height = 5.50 ft, Voids = 40.00%

Stage / Storage Table

Stage (ft)	Elevation (ft)	Contour area (sqft)	Incr. Storage (acft)	Total storage (acft)
0.00	171.50	n/a	0.000	0.000
0.55	172.05	n/a	0.003	0.003
1.10	172.60	n/a	0.006	0.009
1.65	173.15	n/a	0.007	0.016
2.20	173.70	n/a	0.007	0.023
2.75	174.25	n/a	0.007	0.030
3.30	174.80	n/a	0.006	0.036
3.85	175.35	n/a	0.006	0.042
4.40	175.90	n/a	0.005	0.047
4.95	176.45	n/a	0.003	0.050
5.50	177.00	n/a	0.003	0.054

Culvert / Orifice Structures

	[A]	[B]	[C]	[PrfRsr]
Rise (in)	= 12.00	5.00	5.00	0.00
Span (in)	= 12.00	5.00	5.00	0.00
No. Barrels	= 1	1	1	0
Invert El. (ft)	= 171.00	171.50	173.60	0.00
Length (ft)	= 40.00	0.00	0.00	0.00
Slope (%)	= 10.00	0.00	0.00	n/a
N-Value	= .012	.013	.013	n/a
Orifice Coeff.	= 0.60	0.60	0.60	0.60
Multi-Stage	= n/a	Yes	Yes	No

Weir Structures

	[A]	[B]	[C]	[D]
Crest Len (ft)	= 4.00	0.00	0.00	0.00
Crest El. (ft)	= 175.50	0.00	0.00	0.00
Weir Coeff.	= 3.33	3.33	3.33	3.33
Weir Type	= Rect	---	---	---
Multi-Stage	= Yes	No	No	No
Exfil.(in/hr)	= 0.000 (by Wet area)			
TW Elev. (ft)	= 0.00			

Note: Culvert/Orifice outflows are analyzed under inlet (ic) and outlet (oc) control. Weir risers checked for orifice conditions (ic) and submergence (s).

Stage / Storage / Discharge Table

Stage ft	Storage acft	Elevation ft	Clv A cfs	Clv B cfs	Clv C cfs	PrfRsr cfs	Wr A cfs	Wr B cfs	Wr C cfs	Wr D cfs	Exfil cfs	User cfs	Total cfs
0.00	0.000	171.50	0.00	0.00	0.00	---	0.00	---	---	---	---	---	0.000
0.55	0.003	172.05	0.95 ic	0.38 ic	0.00	---	0.00	---	---	---	---	---	0.384
1.10	0.009	172.60	0.95 ic	0.62 ic	0.00	---	0.00	---	---	---	---	---	0.620
1.65	0.016	173.15	0.95 ic	0.79 ic	0.00	---	0.00	---	---	---	---	---	0.788
2.20	0.023	173.70	0.96 ic	0.93 ic	0.03 ic	---	0.00	---	---	---	---	---	0.954
2.75	0.030	174.25	1.49 ic	1.05 ic	0.44 ic	---	0.00	---	---	---	---	---	1.483
3.30	0.036	174.80	1.82 ic	1.15 ic	0.65 ic	---	0.00	---	---	---	---	---	1.803
3.85	0.042	175.35	2.05 ic	1.24 ic	0.82 ic	---	0.00	---	---	---	---	---	2.052
4.40	0.047	175.90	5.34 ic	1.02 ic	0.95 ic	---	3.37	---	---	---	---	---	5.338
4.95	0.050	176.45	8.25 ic	0.29 ic	0.29 ic	---	7.67 s	---	---	---	---	---	8.245
5.50	0.054	177.00	8.82 ic	0.17 ic	0.17 ic	---	8.48 s	---	---	---	---	---	8.815

ATTACHMENT H

WATERSHED MAPS

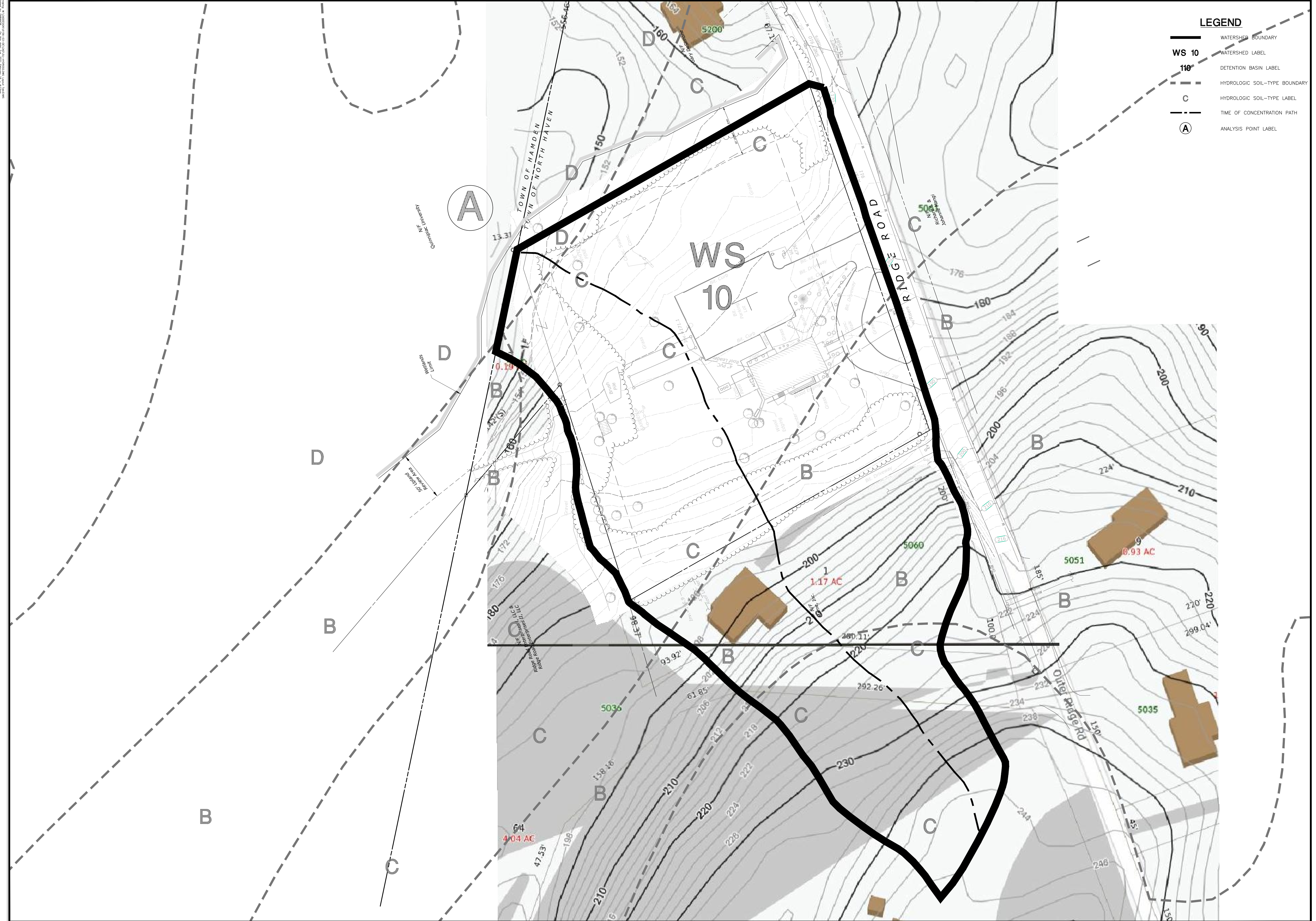

LEGEND

- WATERSHED BOUNDARY
- WS 10** WATERSHED LABEL
- 110** DETENTION BASIN LABEL
- HYDROLOGIC SOIL-TYPE BOUNDARY
- C** HYDROLOGIC SOIL-TYPE LABEL
- TIME OF CONCENTRATION PATH
- (A)** ANALYSIS POINT LABEL

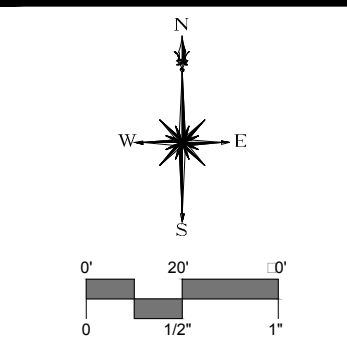

MILONE & MACBROOM
 NOW PART OF **SLR**
 88 BEAVER DRIVE
 CHESHIRE, CT 06810
 203.271.1773
 WWW.MMMINC.COM

DESCRIPTION	DATE	BY
TOWN COMMENTS	12/04/20	FAB

WATERSHED MAP - EXISTING CONDITIONS
SLATE UPPER SCHOOL
 5100 RIDGE ROAD
 NORTH HAVEN, CONNECTICUT

FAB/MCB	MCB	FAB
DESIGNED	DRAWN	CHECKED

SCALE: 1"=40'
 DATE: **OCTOBER 27, 2020**
 PROJECT NO.: **6156-03**
 SHEET NO.: **1 OF 2**

EXWS

11/27/20 - N. LARSEN, LSC, INC. 100% DESIGN OF CONCEPT MAPS AND PLANS FOR THE PROPOSED SLATE UPPER SCHOOL



LEGEND

- WATERSHED BOUNDARY
- WS 10** WATERSHED LABEL
- 110** DETENTION BASIN LABEL
- HYDROLOGIC SOIL-TYPE BOUNDARY
- C** HYDROLOGIC SOIL-TYPE LABEL
- TIME OF CONCENTRATION PATH
- ANALYSIS POINT LABEL

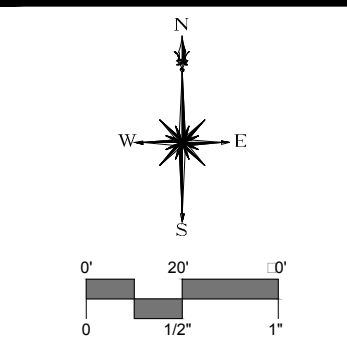

MILONE & MACBROOM
 NOW PART OF **SLR**
 88 BEAVER DRIVE
 CHESHIRE, CT 06410
 203.271.1773
 WWW.MIINC.COM

DESCRIPTION	DATE	BY
TOWN COMMENTS	12/10/20	FAB
WETLANDS HEARING RESPONSES	02/16/21	FAB

WATERSHED MAP - PROPOSED CONDITIONS
SLATE UPPER SCHOOL
 5100 RIDGE ROAD
 NORTH HAVEN, CONNECTICUT

FAB/MCB	MCB	FAB
DESIGNED	DRAWN	CHECKED
SCALE 1"=40'		
DATE OCTOBER 27, 2020		
PROJECT NO. 6156-03		
SHEET NO. 2 OF 2		

PRWS

PROJECT: 6156-03, WATERSHED MAP, SHEET 2 OF 2, 10/27/20
 DRAWN BY: MCB
 CHECKED BY: FAB
 DATE: 10/27/20